

PYRA FLASHING LIGHT SOUNDERS 101 dB(A) / 5/10 J PY X-MA-05 / PY X-MA-10



- Safe – an incorrect installation is virtually impossible
- Easy – significantly shorter assembly and installation times
- Economical – largest possible signaling range due to effective Xenon technology.
- Installation options with external lugs or internal holes.
- Choice of 4 different flash rates via DIP switch.
- Electronic constant current regulation at 24 V AC/DC devices to avoid load fluctuations.
- Integrated inrush current limitation and undervoltage detection.
- Providing full synchronisation on multi-flashing light systems.
- Light and sounder can be controlled separately.



protection system



impact-proof housing



operating temperature



warranty



PRODUCT	PY X-MA-05		
---------	------------	--	--

DATA

Operating range	187–255 V	90–135 V	AC: 18–30 V / DC: 10–57 V
	AC 50 60 Hz	AC 50 60 Hz	AC 50 60 Hz / DC
Nominal current consumption ¹	70–75 mA	120–140 mA	AC: 310 mA DC: 280 mA @ 24 V

PRODUCT	PY X-MA-10		
---------	------------	--	--

DATA







Operating range	187–255 V	90–135 V	10–57 V
	AC 50 60 Hz	AC 50 60 Hz	DC
Nominal current consumption ¹	160–165 mA	250–270 mA	540 mA @ 24 V

PRODUCT	PY X-MA-05	PY X-MA-10
Sound pressure level	101 dB(A)	
Sound pressure level @DIN-tone	99 dB(A)	
Sound level reduction	max. –20 dB via potentiometer	
Alarm tones	8	
Flash energy and flash rate	5 J @ 0.1 0.5 0.75 1 Hz	10 J @ 0.1 0.5 0.75 1 Hz
Light intensity (DIN 5037) ²	56 cd	149 cd
Operating temperature	–40 °C ... +55 °C	
Storage temperature	–40 °C ... +70 °C	
Relative humidity	90 %	
Protection system (EN 60529)	IP 66	
Protection class	II	
Service life of the light source	light emission still 70 % after 8,000,000 flashes	
Material	base part PC / ABS, RAL 3000 (flame red) / RAL 7035 (light grey)	
	lens flashing light  polycarbonate (PC)	
Cable entry	2x M20 on side, 1x M20 on bottom	
Integrated seal with cable entry	6–13 mm	
Connecting terminals	2.5 mm ² fine wire, AWG 16	
Weight	AC	620 g
	AC/DC	560 g
		660 g
		580 g

¹ power consumption dependent on operating voltage

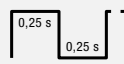
² with a clear lens

TONE TABLE

NO.	DESCRIPTION		NO.	DESCRIPTION	
2	Sawtooth, DIN tone 33404-3 Germany (emergency signal), PFEER PTAP	1200 Hz 500 Hz 	160	Continuous tone (horn)	110 Hz — —
9	Slow whoop, fire alarm, UK BS5839-1	970 Hz 800 Hz 1 s 	161	Continuous tone	3000 Hz — —
131	Alternating tone, UK BS5839-1 (fire alarm, railway crossing)	1000 Hz 800 Hz 0,25 s 0,25 s 	162 ¹	Interrupted tone	3000 Hz 0,5 s 0,5 s 
			163	Interrupted tone	3000 Hz 25 ms 25 ms 
			164	Slow whoop	2850 Hz 2400 Hz 143 ms 

¹ factory setting

OPTIONS/ACCESSORIES



ARTICLE NO.		PY X-MA-05			PY X-MA-10		
HOUSING COLOUR	LENS COLOUR	230 V AC	115 V AC	24 V AC/DC	230 V AC	115 V AC	24 V DC
●	/	21554101000	21554151000	21554811000	21555101000	21555151000	21555811000
●	●	21554103000	21554183000	21554813000	21555103000	21555153000	21555813000
●	●	21554105000	21554155000	21554815000	21555105000	21555155000	21555815000
●	/	21554101055	21554151055	21554811055	21555101055	21555151055	21555811055
●	●	21554103055	21554153055	21554813055	21555103055	21555153055	21555813055
●	●	21554105055	21554155055	21554815055	21555105055	21555155055	21555815055

Article numbers for other voltages and versions on request.

OPTIONS/ACCESSORIES

ARTICLE NO.		PY X-MA-05 PY X-MA-10
Surface gasket	Sealing of the sounder installation surface when, e.g. cable entry is executed from the back.	28000500000
Tamper-proof sealing (pack of 4)	Anti-tamper sealing for fasteners of the PATROL or PYRA devices after installation in order to prevent manipulation of the devices.	28300000002

DIMENSIONS

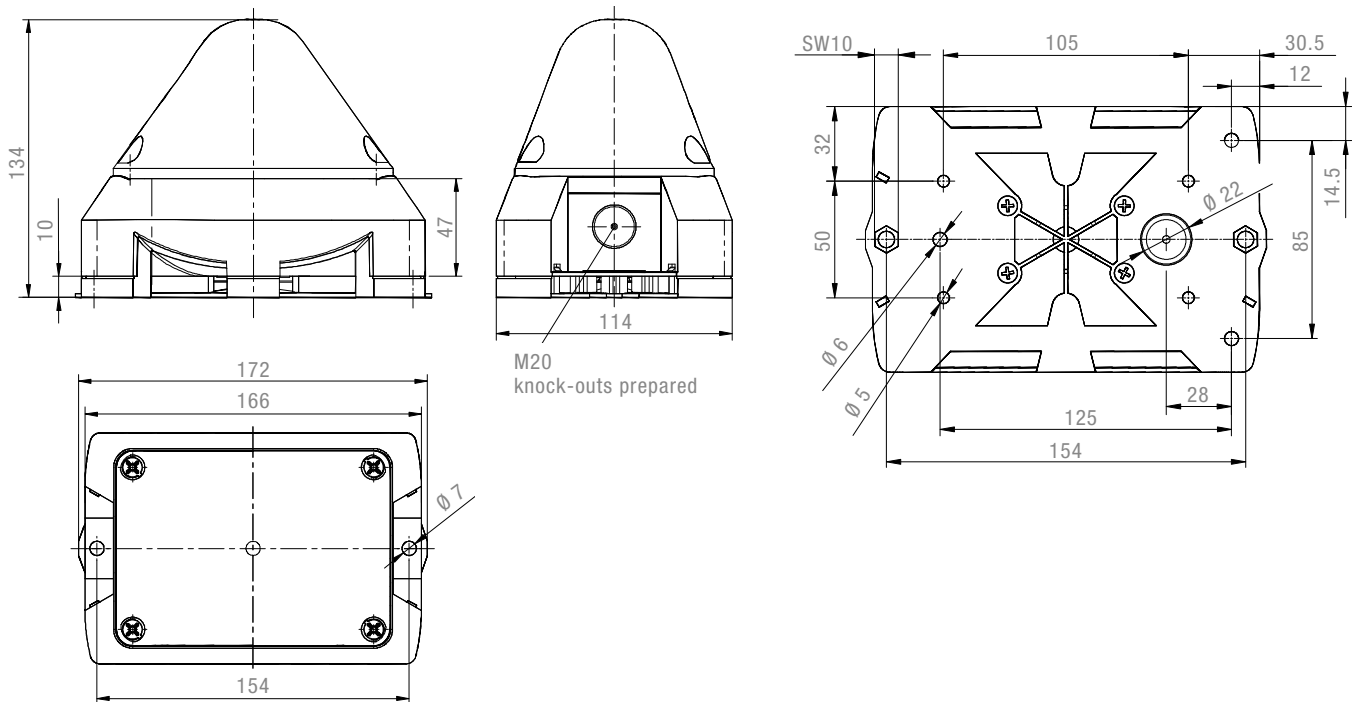

CONNECTION DIAGRAM

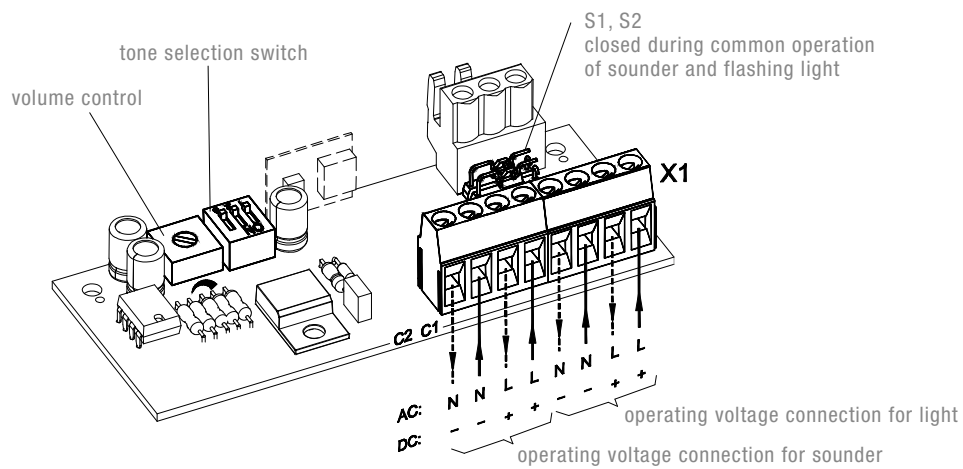

CONFORMITY TO STANDARDS

The acoustic parameters conform to the European standard DIN EN ISO 7731: "Ergonomic – alarms for public areas and workplaces – acoustic alarms".

The requirement for an acoustic alarm signal can be found in the harmonised standards:
 EN 60204-1 Electrical equipment of machines
 EN 60825-1 Radiation safety of laser devices, identical to IEC 825 and DIN-VDE 0837