

SOUNDER 113 dB(A) BExS 110 d/e | BExDS 110 d/e



- 32 different tones can be set; UK00A/PFEER conform.
- 113 dB(A) ±3 dB(A) sound pressure.
- 3 externally selectable tones – positive and negative control possible in the case of DC devices.
- Quartz-stabilised tone synchronisation.
- Adjustable volume (except 12 V DC).
- ATEX and optionally IECEx approval.
- Housing made of die-cast aluminium LM6, horn made of ABS.
- Stainless steel mounting bracket for 360° positioning.
- Categories 2G and 3G (Zones 1 and 2).
- Also available as categories 2D & 3D (Zones 21 & 22) for dust zones.
- Amendment 2; extended approval/temperature range +70 °C.

IP 66
IP 67

protection system

+70 °C
-50 °C

operating temperature

EN
54-3

Exd
24V DC

VdS
G209081

Exd
24V DC



PRODUCT DATA **BExS 110 d/e | BExDS 110 d/e**

Rated voltage	230 V	115 V	48 V	24 V	12 V
	AC 50 60 Hz		DC		
Operating range	±10 %		±25 %		
Nominal currenconsumption	56 mA	110 mA	130 mA	265 mA	195 mA











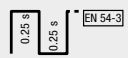

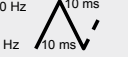





PRODUCT **BExS 110 d/e** **BExDS 110 d/e**

Protection system	"d" = IP 67; or "e" = IP 66	
Explosion protection	II 2G Ex d IIC T4 / II 2G Ex de IIC T4 II 2G Ex d IIB T4 / II 2G Ex de IIB T4	II 2G/D Ex d IIC T4 100°C / II 2G/D Ex de IIC T4 100°C II 2G/D Ex d IIB T4 115°C / II 2G/D Ex de IIB T4 115°C
Category (area of use)	2G (Zone 1) 3G (Zone 2)	2G (Zone 1) / 2D (Zone 21) 3G (Zone 2) / 3D (Zone 22)
Certificate of conformity	KEMA 99 ATEX 7906	
Testing body	KEMA	
Sound pressure level	113 dB(A) ±3 dB(A)	113 dB(A) ±3 dB(A)
Sound pressure level @DIN-tone	112 dB(A) ±3 dB(A)	112 dB(A) ±3 dB(A)
Sound level reduction	max. -9 dB(A)	
Alarm tones	32	
Temperature class T	IIC: T4 @ -50 °C ... +55 °C Ta IIB: T4 @ -50 °C ... +70 °C Ta	T4 @ -50 °C ... +55 °C Ta
Storage temperature	-50 °C ... +70 °C	
Relative humidity	90 %	
Duty cycle	100 %	
Material	housing	die-cast aluminium LM6, similar to RAL 3000 (flame red)
	horn	ABS self-extinguishing, similar to UL 94 V0 & 5VA FR ABS, Ex II 2D anti-static ABS, black
Connecting terminals	Exd	1x 4 mm2 or 2x 2.5 mm2
	Exde	2x 2.5 mm2
Cable entry	2 / 1x closed, 1x open (M20), optionally PG13.5 or 1/2" NPT	
Weight	Exd	AC: 3.42 kg DC: 3.16 kg
	Exde	AC: 3.68 kg DC: 3.42 kg

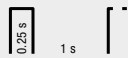
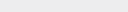
OPTIONS/ACCESSORIES

IECEx
No. SIM
04.0001

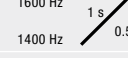
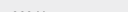
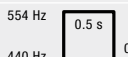
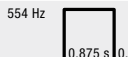
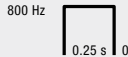
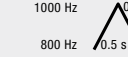
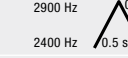
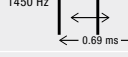
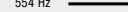
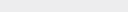
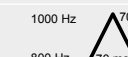
Exd
BExDS

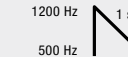
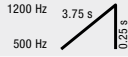
TONE TABLE							
No.	Description - basic tone	Stage		No.	Description - basic tone	Stage	
		2	3			2	3
1	Continuous tone	1000 Hz		31	11		
2 ¹	Alternating tone, UK BS5839-1 (fire alarm, railway crossing)	1000 Hz 800 Hz		17	5		
3	Slow whoop	1200 Hz 500 Hz		2	5		
4	Sweeping (fast)	1000 Hz 800 Hz		6	5		
5	Continuous tone	2400 Hz		3	27		
6	Sweeping	2900 Hz 2400 Hz		7	5		
7	Sweeping (fast)	2900 Hz 2400 Hz		10	5		
8	Sweeping	1200 Hz 500 Hz		2	5		
9	Sawtooth, DIN tone 33404-3 Germany (emergency signal), PFEER PTAP	1200 Hz 500 Hz		15	2		
10	Alternating tone	2900 Hz 2400 Hz		7	5		
11	Interrupted tone	1000 Hz		31	1		
12	Alternating tone	1000 Hz 800 Hz		4	5		
13	Interrupted tone	2400 Hz		15	5		
14	Interrupted tone	800 Hz		4	5		
15	Continuous tone	800 Hz		2	5		
16	Interrupted tone	660 Hz		18	5		
17	Alternating tone, France NFS 32-001 (fire alarm)	554 Hz 440 Hz		2	27		
18	Interrupted tone, Sweden SS031711 (air raid warning)	660 Hz		2	5		
19	Sweeping, France NFC48-265	1600 Hz 1400 Hz		2	5		
20	Continuous tone, Sweden SS031711 (all-clear signal)	660 Hz		2	5		
21	Alternating tone Sweden SS031711	554 Hz 440 Hz		2	5		
22	Interrupted tone	554 Hz		2	5		
23	Interrupted tone	800 Hz		6	5		
24	Sweeping (medium), UK BS5839-1	1000 Hz 800 Hz		29	5		
25	Sweeping	2900 Hz 2400 Hz		29	5		
26	Interrupted tone, (fast variable), bell	1450 Hz		2	1		
27	Continuous tone	554 Hz		26	5		
28	Continuous tone	440 Hz		2	5		
29	Sweeping (fast), UK BS5839-1	1000 Hz 800 Hz		7	5		
30	Interrupted tone, Australia AS2220, AS1610, AS1670	420 Hz		32	5		
31	Sawtooth, DIN tone 33404-3 Germany (emergency signal)	1200 Hz 500 Hz		11	1		
32	Slow whoop, Australian evacuation alarm AS2220	1200 Hz 500 Hz		26	1		

¹ factory setting

The Sounder can be set externally to the respective tones of a stage 2 & 3. Tone 2 is preset.

ARTICLE NO.	BExS 110D		BExS 110E		BExDS 110D	BExDS 110E
Rated voltage	230 V AC	24 V DC	230 V AC	24 V DC	230 V AC	230 V AC
	32080100000	32080800000	32082100000	32082800000	32075100000	32085100000

DIMENSIONS

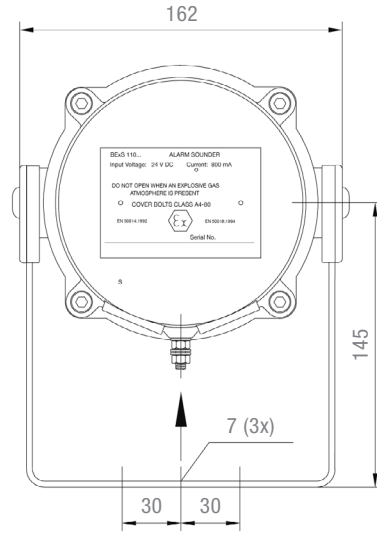
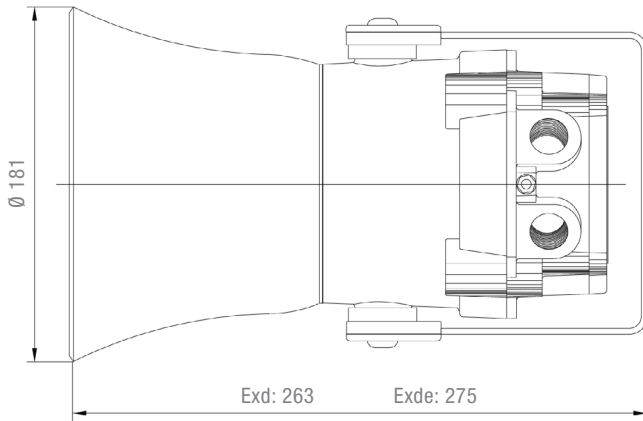

CONNECTION DIAGRAMS

AC

DC

