

# MDS SD Series

## Secure, Long Range IP/Ethernet & Serial

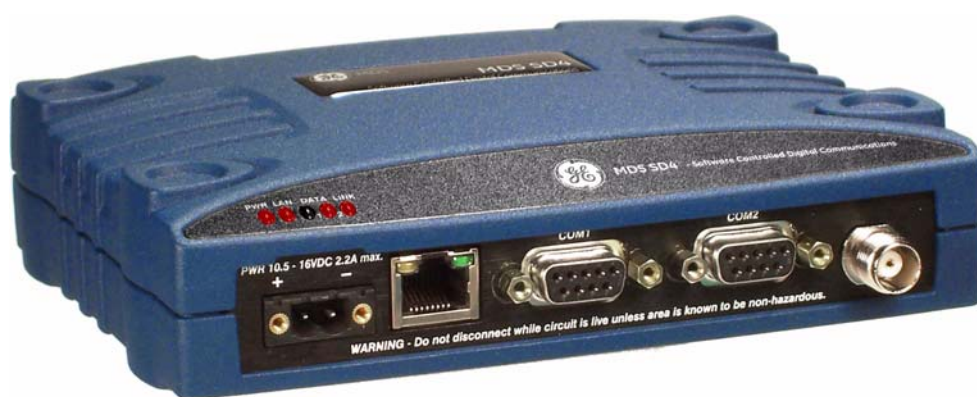

*Covering ES/SS Units with Firmware Version 5.x*

*Applies to all models **EXCEPT** those operated in x710 Mode. For x710 mode operation, refer to Publication 05-4670A01.*

MDS 05-4846A01, Rev. H  
November 2013



Digital Energy  
MDS

*Quick-Start instructions for this product are contained in publication 05-4847A01.*

All GE MDS manuals and updates are available online at **[www.gemds.com](http://www.gemds.com)**.

---

# TABLE OF CONTENTS

---

1.0 INTRODUCTION .....	1
1.1 Conventions Used in This Manual .....	1
1.2 New Features in this Release .....	2
2.0 PRODUCT DESCRIPTION.....	3
2.1 Front Panel Connectors and Indicators .....	3
2.2 Key Product Features .....	4
Media Access Control (MAC).....	4
VLAN Capability.....	5
Terminal Server Capability .....	5
Store and Forward Capability.....	5
Peer-to-Peer Capability.....	6
Frequency Re-use (System ID) .....	6
2.3 SD Model Offerings .....	6
2.4 Operating Modes and Applicable Manuals .....	6
2.5 Accessories and Spares .....	8
Protected Network Station .....	8
Dual Protected Configurations .....	9
3.0 TYPICAL APPLICATIONS .....	11
3.1 Operating Parameters .....	11
3.2 Example Systems .....	12
Multiple Address Systems (MAS) .....	12
Point-to-Point System .....	12
IP Payload/Ethernet Polling and Terminal Server Operation .....	13
Port Sharing with Multiple Hosts .....	14
Push Communication (Report-by Exception).....	15
IP Polling of Serial Remotes .....	15
IP Polling of Two Serial Ports on One Remote .....	16
4.0 INSTALLATION PLANNING .....	18
4.1 Chassis Dimensions .....	19
4.2 Mounting Bracket Options .....	19
Optional DIN Rail Mounting .....	20
4.3 Antennas and Feedlines .....	20
Antennas.....	20
Feedlines .....	21
4.4 DC Power Connection .....	22
4.5 Grounding Considerations .....	22
4.6 Ethernet Data Interface (RJ-45) .....	23

4.7	Serial Data Interfaces .....	24
	COM1 (Serial) Connection .....	24
	COM2 (Data) Connections.....	25
<b>5.0</b>	<b>STEP-BY-STEP INSTALLATION .....</b>	<b>28</b>
5.1	Initial Configuration .....	29
	Web-Based Management .....	29
	Web Browser Connection .....	30
	Alternative Management Methods .....	32
5.2	Initial Startup & Checkout .....	33
	Ethernet Connector LEDs .....	33
5.3	Optimizing the Radio Network .....	34
	Modem Type Setting .....	34
	Inter-Packet Gap Settings.....	34
	Baud Rate Setting.....	34
	Ethernet Settings .....	35
	Antenna SWR Check.....	35
<b>6.0</b>	<b>USING THE DEVICE MANAGER.....</b>	<b>36</b>
6.1	Navigating the Screens .....	36
	Overview Screen.....	37
6.2	Management Tasks .....	38
6.3	Configuration Screens .....	43
	Radio.....	43
	Store and Forward Operation.....	49
	Features.....	55
	Understanding the Use of Virtual Radio Channels (VRCs).....	60
	Using the Terminal Server—Typical Example .....	63
	Communications Ports.....	67
	Security .....	70
6.4	Maintenance & Status Screen .....	73
	Event Log.....	73
	Alarm Summary .....	74
	Performance .....	75
	Firmware Utilities .....	81
	Configuration Files.....	85
<b>7.0</b>	<b>TROUBLESHOOTING.....</b>	<b>87</b>
7.1	LED Indicators .....	89
7.2	Checking for Alarms/Events .....	89
	Major Alarms vs. Minor Alarms.....	89
	Status and Informational Events .....	90
	Event Code Definitions .....	90
7.3	Operating Constraints .....	91
<b>8.0</b>	<b>TECHNICAL REFERENCE .....</b>	<b>93</b>
8.1	Performing Network-Wide Remote Diagnostics .....	93
	Setting Up Diagnostics.....	94

8.2	Over-the-Air Firmware Upgrades .....	94
	Intrusive vs. Passive (Non-Intrusive) Mode .....	95
	Broadcast Reprogramming Suggestions by Network Type .....	96
	OTA Reprogramming Overview .....	97
	Cancelling OTA Reprogramming .....	97
	Error Conditions/Recovery .....	97
	Execution and Screen Examples .....	98
8.3	COM1 Operating Modes .....	99
	Changing COM1 Modes .....	99
8.4	Implementing Sleep Mode .....	99
8.5	Technical Specifications .....	101
8.6	dBm-Watts-Volts Conversion Chart .....	103
9.0	GLOSSARY OF TERMS & ABBREVIATIONS .....	104

## Copyright and Trademark

This manual and all software described herein is protected by Copyright: 2013 GE MDS, LLC. All rights reserved. GE MDS, LLC reserves its right to correct any errors and omissions in this publication. Modbus® is a registered trademark of Schneider Electric Corporation. All other trademarks and product names are the property of their respective owners.

## RF Safety Notice (English and French)

### RF Exposure



Concentrated energy from a directional antenna may pose a health hazard to humans. Do not allow people to come closer to the antenna than the distances listed in the table below when the transmitter is operating. More information on RF exposure can be found online at the following website:  
**[www.fcc.gov/oet/info/documents/bulletins](http://www.fcc.gov/oet/info/documents/bulletins)**.

### l'exposition aux RF



Concentré d'énergie à partir d'une antenne directionnelle peut poser un risque pour la santé humaine. Ne pas permettre aux gens de se rapprocher de l'antenne que les distances indiquées dans le tableau ci-dessous lorsque l'émetteur est en marche. Plus d'informations sur l'exposition aux RF peut être trouvé en ligne à l'adresse suivante: [www.fcc.gov / oet / info / documents](http://www.fcc.gov/oet/info/documents) et bulletins.

### Antenna Gain vs. Minimum RF Safety Distance

	Antenna Gain		
	0–5 dBi	5–10 dBi	10–16.5 dBi
Safety Distance (SD4)	0.79 meter	1.41 meters	3.05 meters

### Antenna Gain vs. Minimum RF Safety Distance

	Antenna Gain		
	0–5 dBi	5–10 dBi	10–16.5 dBi
<b>Safety Distance (SD9)</b>	0.46 meter	.82 meters	1.74 meters
<b>Safety Distance (SD1)</b>	For SD1, maintain an RF safety distance of 1.80 meters for a 7 dBd (9.15 dBi) antenna. Use of higher gain antennas means increasing the distance accordingly.		
<b>Safety Distance (SD2)</b>	For SD2, maintain an RF safety distance of 1.50 meters for a 7 dBd (9.15 dBi) antenna. Use of higher gain antennas means increasing the distance accordingly.		
<b>Safety Distance (other models):</b>	Consult factory prior to operation.		

## FCC Part 15 Notice

Operation is subject to the following two conditions: (1) this device may not cause harmful interference, and (2) this device must accept any interference received, including interference that may cause undesired operation. Any unauthorized modification or changes to this device without the express approval of the manufacturer may void the user's authority to operate this device. Furthermore, this device is intended to be used only when installed in accordance with the instructions outlined in this manual. Failure to comply with these instructions may void the user's authority to operate this device.

## Industry Canada Notice

This Class A digital apparatus complies with Canadian ICES-003.

Cet appareil numérique de la classe A est conforme à la norme NMB-003 du Canada.

## Servicing Precautions

When servicing energized equipment, be sure to wear appropriate Personal Protective Equipment (PPE). During internal service, situations could arise where objects accidentally contact or short circuit components and the appropriate PPE would alleviate or decrease the severity of potential injury. When servicing radios, all workplace regulations and other applicable standards for live electrical work should be followed to ensure personal safety.

## Manual Revision and Accuracy

This manual was prepared to cover a specific version of firmware code. Accordingly, some screens and features may differ from the actual unit you are working with. While every reasonable effort has been made to ensure the accuracy of this publication, product improvements may also result in minor differences between the manual and the product shipped to you. If you have additional questions or need an exact specification for a product, please contact GE MDS using the information at the back of this guide. In addition, manual updates can be found on our web site at [www.gemds.com](http://www.gemds.com)

## Environmental Information

The manufacture of this equipment has required the extraction and use of natural resources. Improper disposal may contaminate the environment and present a health risk due to hazardous substances contained within. To avoid dissemination of these substances into our environment, and to limit the demand on natural resources, we encourage you to use the appropriate recycling systems for disposal. These systems will reuse or recycle most of the materials found in this equipment in a sound way. Please contact GE MDS or your supplier for more information on the proper disposal of this equipment.

**Battery Disposal**—This product may contain a battery. Batteries must be disposed of properly, and may not be disposed of as unsorted municipal waste in the European Union. See the product documentation for specific battery information. Batteries are marked with a symbol, which may include lettering to indicate cadmium (Cd), lead (Pb), or mercury (Hg). For proper recycling return the battery to your supplier or to a designated collection point.

## Product Test Data Sheets

Test Data Sheets showing the original factory test results for this unit are available upon request from the GE MDS Quality Leader. Contact the factory using the information at the back of this manual. Serial numbers must be provided for each product where a Test Data Sheet is required.

## CSA/us Notice

This product is approved for use in Class 1, Division 2, Groups A, B, C & D Hazardous Locations. Such locations are defined in Article 500 of the National Fire Protection Association (NFPA) publication NFPA 70, otherwise known as the National Electrical Code. The transceiver has been recognized for use in these hazardous locations by the Canadian Standards Association (CSA) which also issues the US mark of approval (CSA/us). The CSA Certification is in accordance with CSA STD C22.2 No. 213-M1987.

**CSA Conditions of Approval:** The transceiver is not acceptable as a stand-alone unit for use in the hazardous locations described above. It must either be mounted within another piece of equipment which is certified for hazardous locations, or installed within guidelines, or conditions of approval, as set forth by the approving agencies. These conditions of approval are as follows: The transceiver must be mounted within a separate enclosure which is suitable for the intended application. The antenna feedline, DC power cable and interface cable must be routed through conduit in accordance with the National Electrical Code. Installation, operation and maintenance of the transceiver should be in accordance with the transceiver's installation manual, and the National Electrical Code. Tampering or replacement with non-factory components may adversely affect the safe use of the transceiver in hazardous locations, and may void the approval. A power connector with screw-type retaining screws as supplied by GE MDS must be used.



Do not disconnect equipment unless power has been switched off or the area is known to be non-hazardous. Refer to Articles 500 through 502 of the National Electrical Code (NFPA 70) for further information on hazardous locations and approved Division 2 wiring methods.

## BSD License Information

The SD Series products contain source code originally released as part of “WPA Supplicant” which is copyrighted as indicated below and is redistributed under the terms of the BSD license:

WPA Supplicant

Copyright (c) 2003-2010, Jouni Malinen <[j@w1.fi](mailto:j@w1.fi)> and contributors

All Rights Reserved.

BSD License

-----

Redistribution and use in source and binary forms, with or without modification, are permitted provided that the following conditions are met:

1. Redistributions of source code must retain the above copyright notice, this list of conditions and the following disclaimer.
2. Redistributions in binary form must reproduce the above copyright notice, this list of conditions and the following disclaimer in the documentation and/or other materials provided with the distribution.
3. Neither the name(s) of the above-listed copyright holder(s) nor the names of its contributors may be used to endorse or promote products derived from this software without specific prior written permission.

THIS SOFTWARE IS PROVIDED BY THE COPYRIGHT HOLDERS AND CONTRIBUTORS “AS IS” AND ANY EXPRESS OR IMPLIED WARRANTIES, INCLUDING, BUT NOT LIMITED TO, THE IMPLIED WARRANTIES OF MERCHANTABILITY AND FITNESS FOR A PARTICULAR PURPOSE ARE DISCLAIMED. IN NO EVENT SHALL THE COPYRIGHT OWNER OR CONTRIBUTORS BE LIABLE FOR ANY DIRECT, INDIRECT, INCIDENTAL, SPECIAL, EXEMPLARY, OR CONSEQUENTIAL DAMAGES (INCLUDING, BUT NOT LIMITED TO, PROCUREMENT OF SUBSTITUTE GOODS OR SERVICES; LOSS OF USE, DATA, OR PROFITS; OR BUSINESS INTERRUPTION) HOWEVER CAUSED AND ON ANY THEORY OF LIABILITY, WHETHER IN CONTRACT, STRICT LIABILITY, OR TORT (INCLUDING NEGLIGENCE OR OTHERWISE) ARISING IN ANY WAY OUT OF THE USE OF THIS SOFTWARE, EVEN IF ADVISED OF THE POSSIBILITY OF SUCH DAMAGE.



## 1.0 INTRODUCTION

This manual is one of two publications for users of the MDS SD Series Transceiver shown in Figure 1. It contains an overview of common applications, installation planning data, specifications, troubleshooting, and instructions for using the web-based *Device Manager*. This manual is intended for technical personnel who perform network design, configuration, and troubleshooting of the equipment.

A companion *Setup Guide* is also available (Part no. 05-4847A01). The scope of the Setup Guide is limited to installing the transceiver and placing it in service for the first time. All product documentation can be downloaded free of charge from the GE MDS website at [www.gemds.com](http://www.gemds.com). The website also contains links to Application Bulletins and other product information.



Figure 1. MDS SD Series Transceiver

### 1.1 Conventions Used in This Manual

#### **Software & Device Manager Notations**

This product is designed for software control via a connected PC. To show the names of screen items, keyboard entries, or other information displayed on a PC, a bolded font is used throughout the manual that appears as follows:

**Bolded font example (for screen names and keyboard entries)**

To show the navigation path leading to a particular screen, this same font is used with forward-pointing arrows between screen names. For example, suppose you wish to access the radio's **Features Screen**. The navigation path shown for it would appear as follows:

**Configuration>>Features**

#### **Model Number Notations**

The term "SD" or "SD Series" is used in this manual to denote *all* models in the SD product line. Specific model numbers such as MDS SD1 (150-174 MHz), SD2 (216-235 MHz), SD4 (300-512 MHz), and SD9 (820-960 MHz) are used only when necessary to reference model-specific features.

## **Authorization Features**



Some features of the radio are dependent on purchased options and applicable regulatory constraints. A “key” icon is shown near the heading of any such features. In some cases a feature upgrade may be available. Contact your sales representative for additional information.

### **1.2 New Features in this Release**

The SD transceiver has been updated to include the following functionality in the latest release of the product:

- Peer-to-Peer capability (see Page 6 and Page 67)
- Internal MODBUS TCP to RTU conversion (see Page 62)
- Transparent mode with AES Encryption (see Page 72)
- DLINK AES Encryption (see Page 72)
- System ID (frequency re-use) capability (see Page 6 and Page 45)
- Data Key Hold Time-Out (see Page 9 and Page 54)
- 4800B Modem supports baud mismatch functionality at 300, 1200, and 2400 baud rates. (This feature available with post-version 5.0.9 firmware.)

## 2.0 PRODUCT DESCRIPTION

The transceiver is a software-configurable, industrial radio for use in licensed data acquisition networks. It may be interfaced with a variety of data control equipment including remote terminal units (RTUs), programmable logic controllers (PLCs), flow computers, and similar devices. Data interface connections may be made for both serial (RS-232/RS-485) and Ethernet protocols. It is designed for use in both polled networks and report-by-exception (push) systems.

The radio employs digital signal processing (DSP) technology and a fully digital transmit and receive IF chain to provide robust communications even under adverse conditions. DSP technology also helps eliminate the effects of component variations or temperature changes, resulting in optimized performance.

### 2.1 Front Panel Connectors and Indicators

Figure 2 shows the transceiver's front panel connectors and indicators. These items are referenced in the installation steps and in various other locations in the manual. The transceiver's LED functions are described in Table 10 on Page 33.

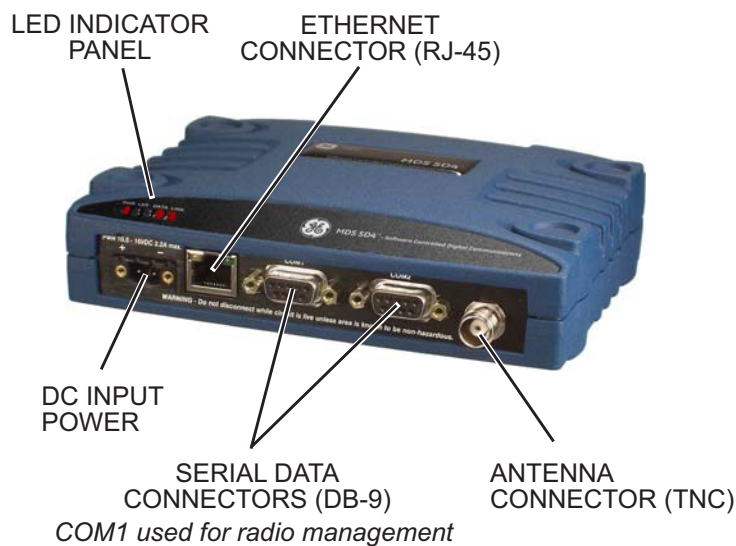

**Figure 2. Front Panel Connectors & Indicators**

## 2.2 Key Product Features

The transceiver is designed to meet the demanding needs of today's wireless networks in a compact, and rugged package. It offers an array of features in a single hardware platform:

- Software-configurable via a built-in *Device Manager*—no manual controls or adjustments.
- Media Access Control (MAC) to prevent data collisions when two or more radios try to use the radio channel at the same time.
- Available encryption of payload data (AES 128-bit)
- Supports Virtual LAN (VLAN) operation
- Terminal Server capability to enable IP addressing of serial interface ports on individual radios
- Store and Forward capability
- Supports a wide variety of modem speeds and bandwidths for regulatory compliance in virtually all regions of the world
- Ethernet & serial interfaces—ideal for migration to IP networks
- Dual serial functionality (RS-232 and RS-485)
- Over-the-air reprogramming of remote units—no unnecessary trips to radio sites
- Licensed 5-watt design, maximizes communications range with low interference risk from other users
- Configurable via software as a Remote or an AP unit
- Low power “sleep mode”—ideal for battery-powered solar sites
- Virtual Radio Channels (VRC) support multiple polling applications on one radio

---

**NOTE:** Some features may not be available on all units, depending on the options purchased and regulatory constraints for the region in which the radio will operate.

---

### Media Access Control (MAC)

An important feature of the transceiver is Media Access Control (MAC). The radio's MAC is specifically designed for use with narrow bandwidth, half duplex radio networks such as those commonly used in licensed telemetry systems. When the MAC is enabled, it provides efficient support of multiple data traffic models including multiple hosts, synchronous and asynchronous polls, and report-by-exception (push traffic). MAC ensures that every transceiver in the network has an equal probability of gaining access to the radio channel when it has data to send.

#### **Coordination of Channel Access**

The main objective of the MAC is to coordinate channel access for all radios in the network, preventing data “collisions” that can occur with simultaneous transmissions from radios on the same RF channel. With MAC operation, a single radio is configured as an Access Point (AP)

and other units are designated as Remotes. The AP serves as the controller of the RF network. Remotes request permission from the AP to use the RF channel before sending payload data, thus avoiding collisions of data, and creating a highly reliable wireless network. The MAC is responsible for allocating which unit gets access to the broadcast medium (the RF channel), when, and for how long.

### **Data Validation**

Additionally, the MAC validates all messages and purges corrupted data from the system. Successful delivery of data is ensured through the use of retries and acknowledgements. Minimal overhead is used to accomplish these tasks, which translates to increased bandwidth efficiency of the radio channel with minimal latency, ensuring that messages are delivered in a timely manner.

### **VLAN Capability**

A Virtual Local Area Network (VLAN) is essentially a limited broadcast domain, meaning that all members of a VLAN receive broadcast frames sent by members of the same network, but not frames sent by members of a different network.

The radio supports port-based VLAN at the Ethernet interface and over the air, in accordance with the IEEE 802.1Q standard. When VLAN Mode is enabled, the wireless ports of both AP and Remote radios act as a “trunk port” to carry data.

### **Terminal Server Capability**

The unit's Terminal Server option allows serial port data to be sent over the air in the form of IP packets. It works by encapsulating data from the serial (COM1/COM2) ports as IP packets, then transmitting it over the air. At the receiving end, the data is decapsulated and delivered to the appropriate COM port. The Terminal Server option provides a front-end RTU conversion for TCP MODBUS Data. See “Terminal Server COM1/2 Configuration” on Page 61 for more information.

### **Store and Forward Capability**

Store and Forward (SAF) capability is only available in Packet w/MAC mode. It allows a radio to store incoming data and retransmit it a short time later to other stations. This can be used to link outlying Remote stations to the AP when direct communication is not possible due to terrain, distance, or other obstructions.

Communication routes are automatically discovered and traffic is intelligently filtered such that only store and forward traffic is sent through the SAF unit, conserving critical bandwidth in the network.

## Peer-to-Peer Capability

Peer to Peer capability is available in Packet w/MAC mode only. It allows Remote radios in the same radio network to pass data directly between each other. When the Peer-to-Peer functionality is enabled on the Remote, both the Remote and the AP will be able to pass data in the system. The AP will route data to and from the enabled peers without disrupting AP-to-Remote specific communications.

## Frequency Re-use (System ID)

Frequency Re-use is possible in some applications. SysID (or System ID as it is referred to in the Device Manager) offers approximately 20 dB of additional co-channel isolation when operating networks on the same frequency (see Page 45 for detailed information). Note that proper system design is required. SysID offers nine unique choices including the default value of **NONE**. Master and Remote radios in the same network must use the same value.

To use this feature, a network must consist of all SDx radios. This feature is applicable *only* on digital modems (B modems are excluded). Note that this feature does *not* affect adjacent channel performance, but only co-channel performance.

## 2.3 SD Model Offerings

The radio is offered in three model types, using one hardware platform:

- **Ethernet (ES)**—All SD features and functionality
- **Standard (SS)**—All SD features, except over-the-air Ethernet data
- **x710 (MS)**—Direct, drop-in compatibility for networks using a mix of SD and older MDS x710 radios

### **Model Number Codes**

The unit's model number is printed on the bottom label. Additional unit details are available through the *Device Manager*, described later in this manual.

## 2.4 Operating Modes and Applicable Manuals

In addition to the model offerings above, the radio may be configured to operate in any of the following modes:

**Standard Modes  
(Modes covered by  
this manual)**

- **Packet Mode**—Payload data from the radio’s serial and Ethernet ports is assembled into packets and transmitted over the air. Packet mode supports Ethernet Bridging, AES 128-bit encryption, and Virtual Radio Channels (VRC). This mode requires an all-SD radio network.
- **Packet w/MAC**—This mode is similar to Packet Mode above, but adds a Media Access Control (MAC) layer to the feature set. The MAC provides robust collision avoidance, with an AP controlling which unit can access the communication channel, and when, for maximum efficiency of the radio channel. This mode supports push traffic, data retry, Virtual Radio Channels (VRC), AES 128-bit encryption, Peer-to-Peer, and Store and Forward operation. This mode requires an all-SD radio network.
- **Transparent Mode**—This mode is over-the-air compatible with MDS x710 transceivers, while supporting payload data encapsulated in IP at the Ethernet port. This mode is ideal for mixed networks containing SD and older MDS x710 radios. It allows currently deployed x710 networks to add support for Ethernet data at either the Master or Remote radios. Note that Ethernet Bridging is not supported in this mode.

Transparent Mode also offers AES Encryption and added security for DLINK polling. DLINK Encryption is *only* available in Transparent Mode when AES Encryption is enabled. Transparent w/AES Encryption requires an all SD radio network.

**x710 Mode:  
Different Manual  
Required**

- **x710 Mode**—This mode provides direct, drop-in compatibility with MDS x710 (4710 or 9710) transceivers, and uses the same core command set as these radios. It is designed for use in systems containing a mix of SD radios and legacy MDS x710 units.

**IMPORTANT: This manual does *not* cover x710 Mode operation. Refer instead to the following manuals for x710 instructions:**

- *Start-Up Guide* (x710 Mode)— Part No. 05-4669A01
- *Technical Manual* (x710 Mode)—Part No. 05-4670A01

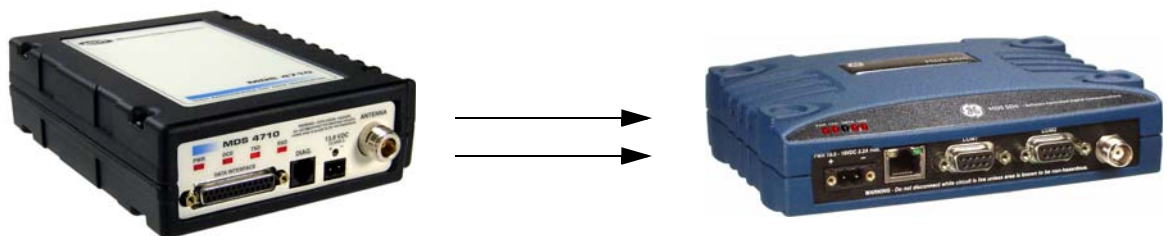

**Figure 3. SD Transceivers offer compatibility with older MDS x710 Transceivers (left), and may be used for replacement and/or interoperability in these networks. A retrofit kit is available for connector conversion (see Table 1).**

## 2.5 Accessories and Spares

Table 1 lists common accessories and spare items for the transceiver. GE MDS also offers an *Accessories Selection Guide* listing additional items that may be used with the product. Visit [www.gemds.com](http://www.gemds.com) or contact your factory representative to obtain a copy of the guide.

**Table 1. Accessories & Spare Items**

Accessory	Description	Part Number
Retrofit Kit, Digital	Contains adapters and connectors needed to facilitate the replacement of an existing MDS x710A/C/M digital transceiver.	03-4696A01
Retrofit Kit, Analog	Contains adapters and connectors needed to facilitate the replacement of an existing MDS x710A/C/M analog transceiver.	03-4697A01
DC Power Plug, 2-pin, polarized	Mates with power connector on radio case. Screw terminals provided for wires, threaded locking screws to prevent accidental disconnect.	73-1194A53
Setup Guide (for Packet and Transparent Modes)	Describes the installation and setup of the transceiver. A companion to this Technical Manual.	05-4847A01
Flat Mounting Bracket Kit	Brackets that attach to the bottom of the unit. Used for mounting to a flat mounting surface. Fits the mounting footprint of MDS x710 transceivers.	03-4123A14
DIN Rail Mounting Bracket Kit	Contains bracket for mounting the transceiver to standard 35 mm DIN rails commonly used in equipment cabinets and panels.	03-4125A04

### Protected Network Station

The transceiver is available in a protected network configuration, known as the **SDxP** (Figure 4), where  $x$  denotes the particular model of SD transceiver installed inside the chassis (*i.e.*, SD1, 2, 4, 9, etc.).

The **SDxP** is a tabletop or rack-mount unit designed to hold two transceivers, two power supplies, and a switchover logic board that automatically selects between transceiver A or B as the active unit. Manual selection may also be made using a front panel switch.



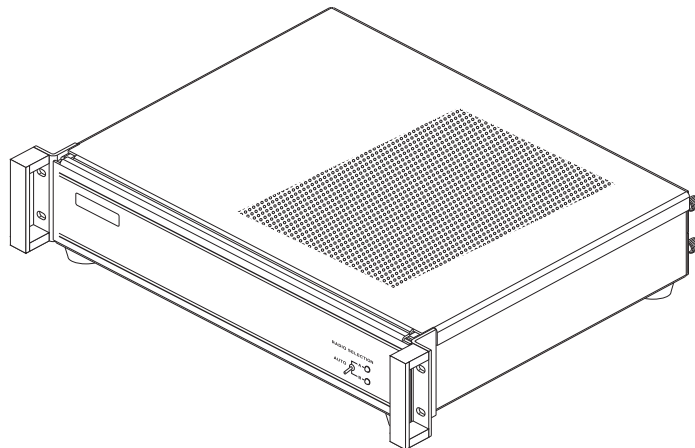

**Figure 4. Protected Network Station**

With two transceivers and two power supplies installed, the unit continues to communicate even if a failure occurs in one of the transceivers, or its associated power supply. This capability is important in critical applications where uninterrupted service is required. Refer to publication 05-4161A01 for detailed information on this product.

### Dual Protected Configurations

Two dual transceiver configurations are offered for the SD Series. They are known as the *SDxDT* and the *SDxDP*. These configurations are used for the following purposes:

- When full duplex operation is desired using dedicated Transmit and Receive transceivers.
- When a Master or Repeater site requires bandpass duplexers due to the presence of co-located antennas.
- When streaming Repeater operation is desired using dedicated Transmit and Receive transceivers

To improve performance in networks that require the use of the modem speed being faster than the baud rate, increase the **Data Key Hold Time-out** parameter which prevents frequent key-up key-down sequences between character times. This parameter can be adjusted between 1 and 10 characters. See **Data Key Hold Time-out** on Page 54 for a complete description.

### ***SDxDT*** **Configuration**

The *SDxDT* uses a similar chassis as the *SDxP* described above. However, one radio is configured with the transmit frequency and the other for the receive frequency, with appropriate connections between them. It also includes a bandpass duplexer tuned to a specific frequency for simultaneous transmission and reception (full duplex) operation. Note that the *SDxDT* provides one serial port and one Ethernet port for user equipment.

## ***SDxDP Configuration***

The SDxDP is a protected, full duplex Master or Repeater site configuration. This consists of *two* SDxP chassis described earlier, with appropriate interconnect cabling between the units. The radios in one SDxP are configured with the transmit frequency and the radios in the other are configured with the receive frequency. The SDxDP also includes a bandpass duplexer tuned to a specific frequency for simultaneous transmission and reception (full duplex) operation.

## 3.0 TYPICAL APPLICATIONS

This section describes common scenarios the transceiver may be used in. A number of variations are possible; If you have unique requirements not found here, it is recommended that you consult a support specialist at GE MDS. Contact information is provided at the back of this manual.

### 3.1 Operating Parameters

The transceiver can operate in both poll-response and “push” communication/report-by-exception networks. In poll-response networks a central Master unit communicates with a number of Remote radios one at a time. The Master exchanges data with the currently-connected Remote, and when finished, it establishes a new connection with the next Remote in the polling order. In push communication/Report by Exception networks, a Remote can also transmit if it has data to send, typically prompted by a change in status conditions from connected data equipment.

The radio includes a number of parameters which may be set to suit the requirements of a particular application. Table 2 provides a summary of common applications, protocols, and radio modes used. Refer to the table to determine what applications can be supported and the required radio mode settings.

**Table 2. Application Types vs. Key Radio Settings**

Application	Protocol (Example)	Recommended Radio Mode	Notes
Polled Bridged Ethernet	MODBUS TCP	Packet w/MAC	May also use Packet mode and enable LBT with Listen on RX.
Bridged Ethernet	IP(ICMP/TCP/UDP/ MODBUS TCP)	Packet w/MAC	May also use Packet mode and enable LBT with Listen on RX.
Mixed Serial and Bridged Ethernet	MODBUS RTU & IP	Packet w/MAC	May also use Packet mode with Multihost feature enabled.
Report by Exception	Serial and/or IP	Packet w/MAC	
Single Poll Multiple Response	Serial and/or IP	Packet w/MAC	
Two or more concurrent serial polling applications (COM2, COM1, and /or IP Payload at master)	DNP3 and Modbus RTU	Packet w/MAC	May also use Packet mode with Multihost feature enabled.
Single Port Serial Polling with encryption (COM2 or COM1)	Modbus RTU	Packet Transparent	AES On AES On
Single Port Serial Polling without encryption (COM2, COM1, or IP Payload at master)	Modbus RTU	Packet Transparent	AES Off AES Off

## 3.2 Example Systems

The following sections describe common system arrangements for the transceiver. Other variations are possible, and if you have questions about a specific application not covered here, you may contact your factory representative using the information at the back of this guide. For typical radio settings in these systems, refer to Table 2 on Page 11.

### Multiple Address Systems (MAS)

This is a common application for the transceiver. It consists of a central Master unit and several associated Remote units as shown in Figure 5. An MAS network provides communication between a central host computer and remote terminal units (RTUs) or other data collection devices in the field. Often, such a system is used to carry telemetry data to and from widely separated remote radios.

Typical MAS applications may be for automatic, remote monitoring of gas wells, water tank levels, electric power distribution systems, and similar control and measurement functions.

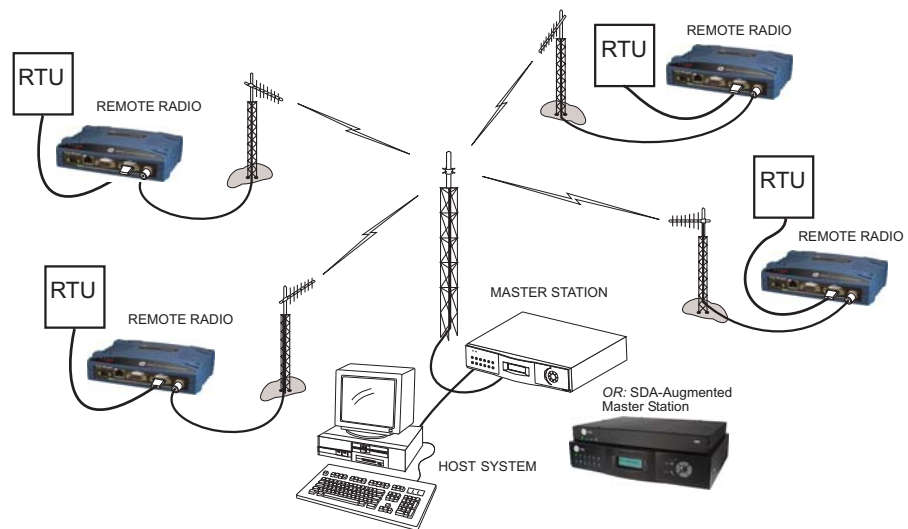

**Figure 5. Typical MAS Point-to-Multipoint Network**

### Point-to-Point System

Where permitted, the transceiver may also be used in a point-to-point arrangement. A point-to-point system consists of just two radios—one Master and one Remote (see Figure 6). It provides a simplex (or half-duplex) and a duplex communications link for the transfer of data between two locations.

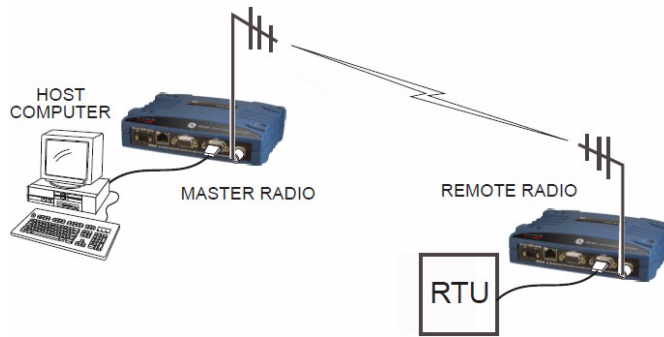
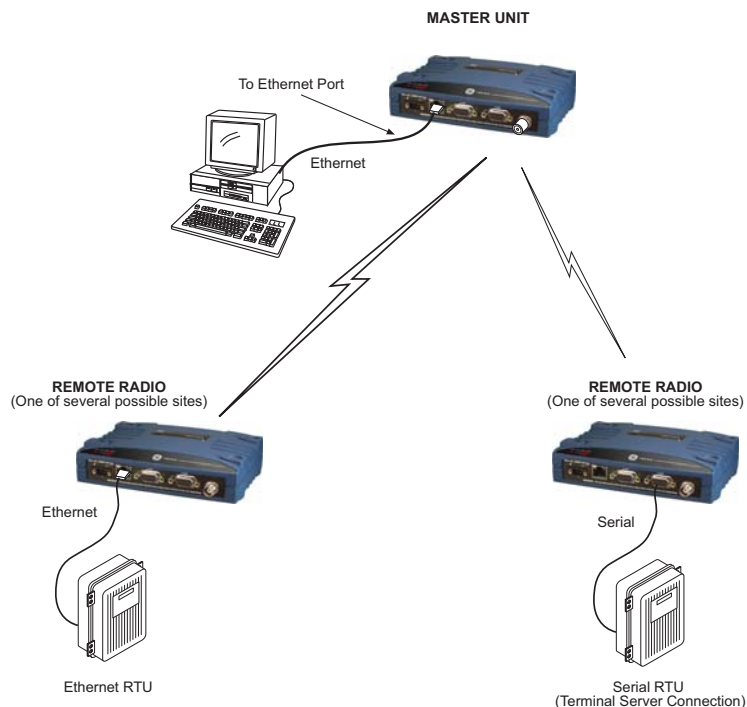

**Figure 6. Typical Point-to-Point Link**

### IP Payload/Ethernet Polling and Terminal Server Operation

Modern data/control networks often employ IP/Ethernet connectivity throughout the system. The transceiver is well suited to provide connectivity between such sites using its RJ-45 modular connector on the front panel and enabling Ethernet Bridging capabilities. Figure 7 shows an overview of such a system.

Note that the Remote radio on the right side of the illustration uses a serial connection. The radio's Terminal Server feature allows direct IP/addressing of serial ports on selected radios. See "Terminal Server COM1/2 Configuration" on Page 61 for more details.



**Figure 7. IP/Ethernet Polling Example**

The type of network shown in Figure 7 can also be used for general Ethernet bridging as supported by the over-the-air bandwidth of the system. Bridge filters in the radio may be set to reduce Ethernet traffic over the RF channel, and improve performance.

### Port Sharing with Multiple Hosts

The transceiver allows for several external data networks to use the same RF network without confusing the data streams. In such a system, multiple host computers at the Master Unit poll their respective RTUs, which may be alone or co-located at the Remote sites. Figure 8 shows an example of such a system. In this case, two host computers (Host A and Host B) are connected to the Master Unit via the applicable data ports.

At the Remote sites, serial and Ethernet-based RTUs are employed, and responding to a specific host computer. In the case of the Remote shown on the lower right side of the figure, two RTUs are co-located, but responding to different host computers and handling entirely different data streams.

The radio eliminates the need for an external adapter or special external configuration and handshaking when multiple host systems are connected to the network. The radio automatically controls access to the RF channel by multiple hosts when Packet w/MAC is activated. Virtual Radio Channels (VRCs) are used to separate serial data streams on COM2, COM1, or IP payload ports. Packet w/MAC operation provides Media Access Control. It is the recommended method of operation for port sharing systems. See “Understanding VRC’s” on Page 60.

---

**NOTE:** An option exists to operate in Packet mode without MAC. However, this Packet mode option should only be used for systems that use legacy methods of collision avoidance including *Multihost* and *Listen Before Transmit (LBT)*. The mode **Packet w/MAC** provides superior performance and better network reliability, collision avoidance and better overall throughput.

---

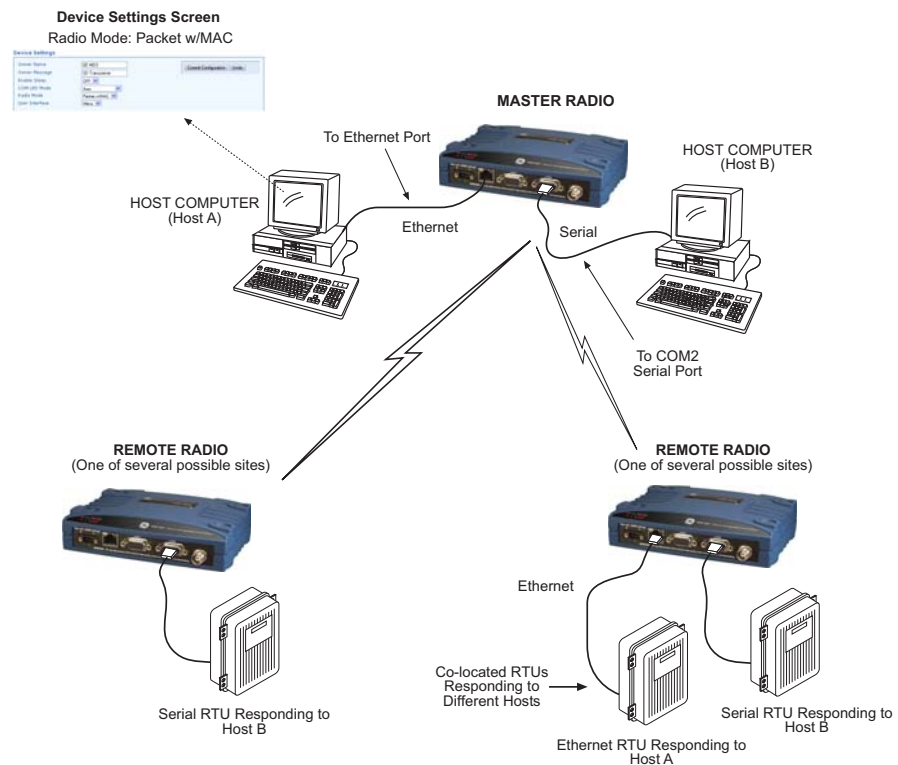

**Figure 8. Port Sharing with Multiple Hosts Arrangement Using Packet w/MAC Mode**

### Push Communication (Report-by Exception)

Push Communication, sometimes referred to as Report-by-Exception (RBE), differs from polled response in that a Remote radio normally transmits only when it has data to send. It does not depend on polling from a Master radio to initiate transmission. Some typical characteristics of push communication systems are as follows:

- Remotes transmit asynchronously
- May contain large amounts of data
- Buffering and flow control are used

DNP3 and IEC 104 are examples of protocols that implement push communication. Note that both the serial and Ethernet versions of DNP3 support push communication.

### IP Polling of Serial Remotes

The transceiver is ideal for use in systems employing a mix of serial and Ethernet protocols. While many variations are possible, Figure 9 shows a typical arrangement with an Ethernet host at the Master Unit that is polling serial-based RTUs at Remote sites.

In this example, the Host Computer is connected directly to the radio's Ethernet port and the RTUs at the Remote sites are connected to the transceiver via the radio's COM2 serial data ports. The IP Payload feature, used at the Master, efficiently passes TCP/UDP payload over the air, and eliminates the need for an external terminal server. (COM1 may also be used for payload data if properly configured via the menu system. See next example.)

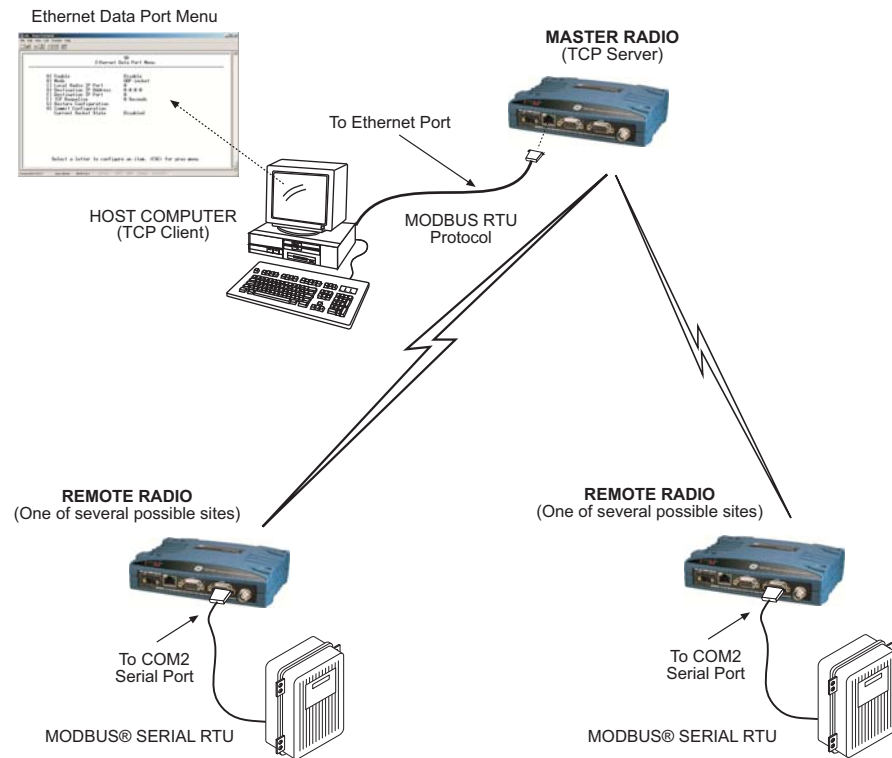

**Figure 9. IP Polling of Serial Remotes**

### IP Polling of Two Serial Ports on One Remote

In some cases, it is necessary to poll more than one RTU at a Remote site. Figure 10 shows an example of such a system. Here, two RTUs are connected to each Remote transceiver, both using the radio's serial ports—COM1 and COM2.

By default, the radio's COM1 port is configured for serial management functions with a connected PC, but it may be configured for data service using the web interface. This arrangement allows two telemetry networks to share a single radio system.



Packet w/MAC is the recommended method of operation when both serial ports are used to pass payload data if there are two hosts (e.g., Port Sharing with multiple host case). If there is a single host polling all units, packet or transparent mode is the preferred option even if there are two RTUs connected to a Remote radio.

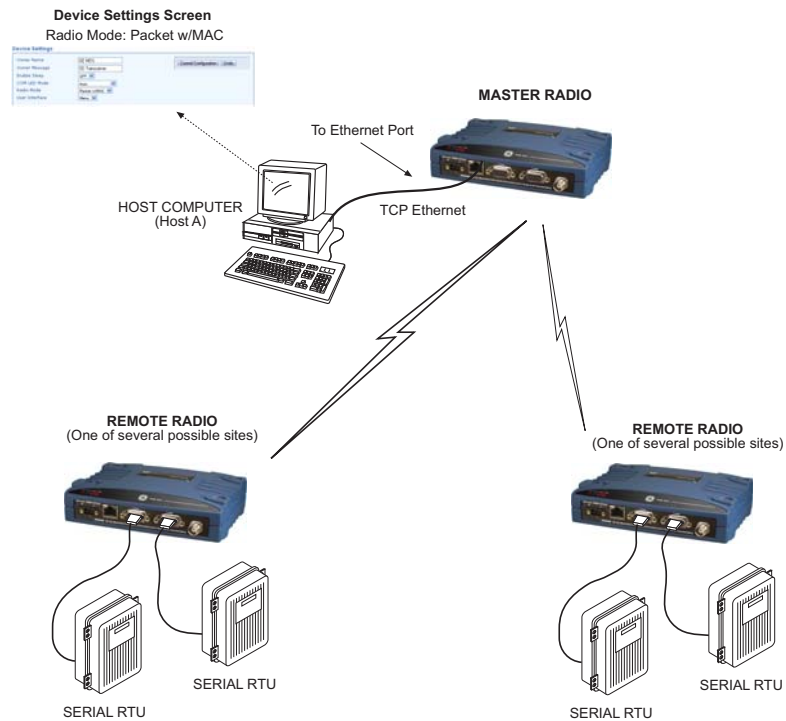

**Figure 10. IP Polling of Two Serial Ports on One Remote**

## 4.0 INSTALLATION PLANNING

This section covers pre-installation factors that should be considered when installing the transceiver in the field. Careful planning will help achieve optimal performance from the transceiver. After reviewing this section, refer to the step-by-step installation procedures beginning on Page 28.

Figure 11 shows a typical station arrangement. The specific details at an installation site may vary, but there are three main requirements for installing the transceiver in all cases:

- Adequate and stable primary power
- An efficient and properly installed antenna system
- Correct interface connections between the transceiver and the data device.

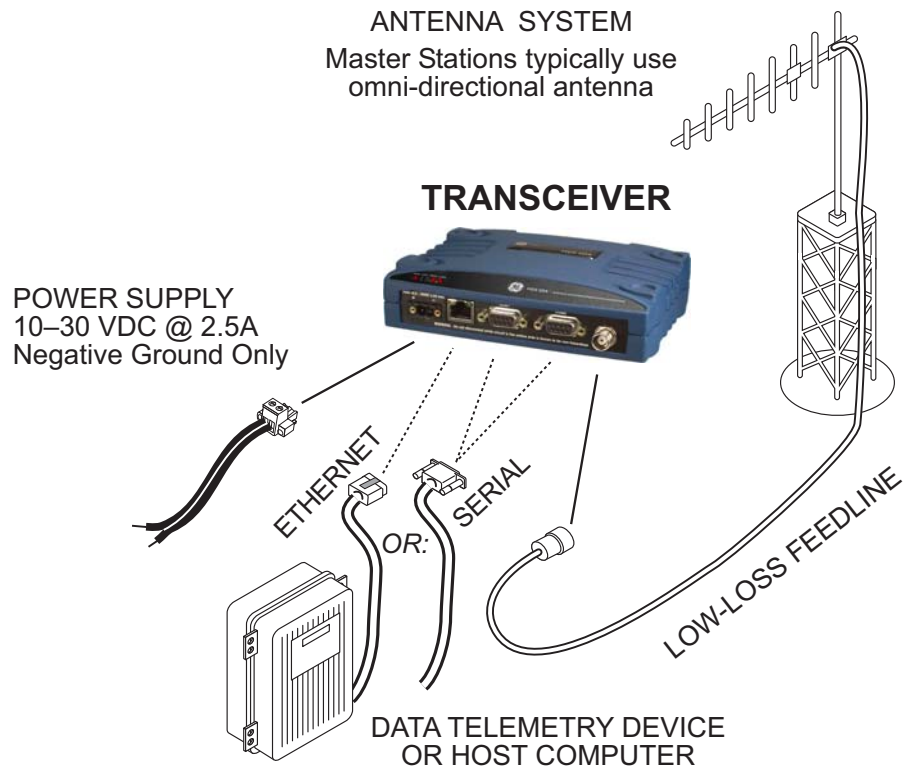

Figure 11. Typical Station Arrangement (Remote shown)

## 4.1 Chassis Dimensions

Figure 12 shows the external chassis dimensions of the SD Transceiver.

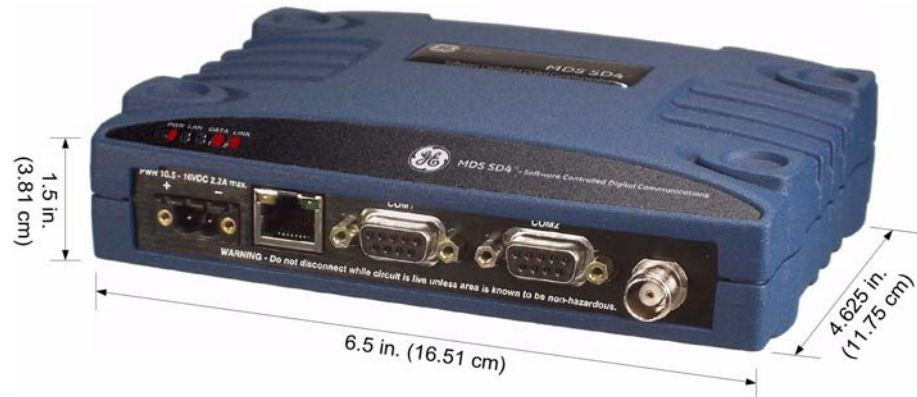

Figure 12. Transceiver Dimensions

## 4.2 Mounting Bracket Options

The transceiver is normally provided with flat mounting brackets attached to the bottom of the radio as shown in Figure 13. An optional 35 mm DIN rail mounting bracket is also available, and is described below.

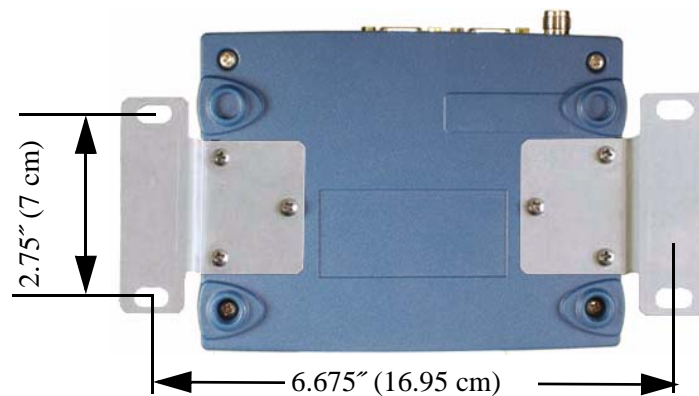

Figure 13. Mounting Bracket Dimensions

---

**NOTE:** To prevent moisture from entering the radio, do not mount the case with the cable connectors pointing up. Also, dress all cables to prevent moisture from running along the cables and into the radio.

---

## Optional DIN Rail Mounting

The unit may be mounted with an optional 35 mm DIN Rail Mounting Bracket Kit (Part No. 03-4125A04). Equipment cabinets and racks of modern design often employ this type of mounting. Once the DIN bracket is attached to the radio, it allows for quick installation and removal of the radio from its mounting rail without the need for tools.

The DIN Rail bracket attaches to the unit's case as shown in Figure 14. The entire assembly then attaches to the mounting rail.

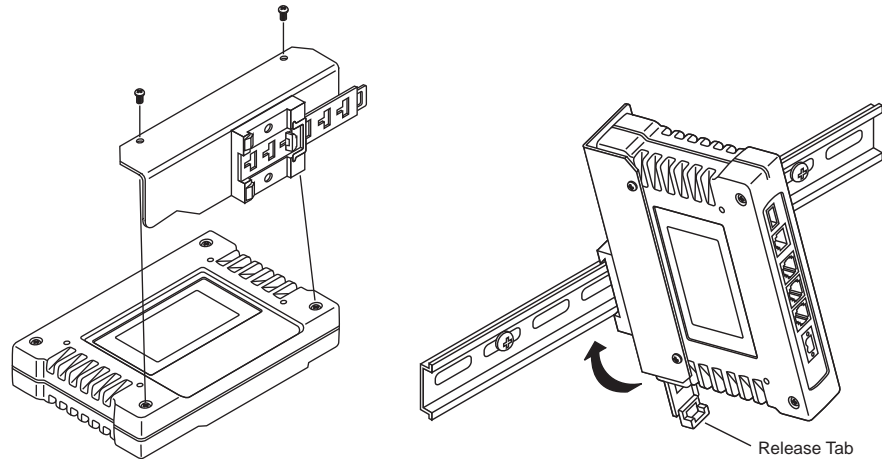

*Step 1: Attach the bracket using the two screws provided. (Attach to the end opposite the unit's connectors.)*

*Step 2: Clip the assembly onto the DIN Rail. Removal is performed by pulling down on the Release Tab.*

**Figure 14. Attachment & Mounting of DIN Rail Bracket**  
(Unit shown is for example only, and is not an SD Transceiver.)

## 4.3 Antennas and Feedlines

### Antennas

The transceiver may be used with a number of different antennas. The exact style and gain factor depend on the physical size and layout of your system. Connection is made to the radio via a TNC coaxial connector.

A directional Yagi (Figure 15) or corner reflector antenna is generally used at remote sites to minimize interference to and from other users. Antennas of this type are available from several manufacturers, including GE MDS. Contact your factory representative for details.

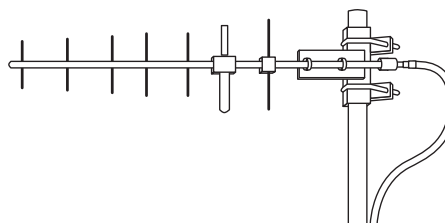

**Figure 15. Typical Yagi Antenna (mounted to mast)**

### Feedlines

The selection of an antenna feedline is very important. Poor quality cable should be avoided as it will result in power losses that may reduce the range and reliability of the radio system.

The tables which follow show the approximate losses that will occur when using various lengths and types of coaxial cable in the 200, 400 and 900 MHz bands, respectively. Regardless of the type used, the cable should be kept as short as possible to minimize signal loss.

**Table 3. Signal Loss in Coaxial Cables (at 200 MHz)**

Cable Type	10 Feet (3 Meters)	50 Feet (15 Meters)	100 Feet (30.5 Meters)	200 Feet (61 Meters)
RG-8A/U	0.26 dB	1.27 dB	2.50 dB	5.07 dB
1/2 inch HELIAX	0.06 dB	0.38 dB	0.76 dB	1.60 dB
7/8 inch HELIAX	0.04 dB	0.21 dB	0.42 dB	0.83 dB
1-1/4 inch HELIAX	0.03 dB	0.16 dB	0.31 dB	0.62 dB
1-5/8 inch HELIAX	0.025 dB	0.13 dB	0.26 dB	0.52 dB

**Table 4. Signal Loss in Coaxial Cables (at 400 MHz)**

Cable Type	10 Feet (3 Meters)	50 Feet (15 Meters)	100 Feet (30.5 Meters)	200 Feet (61 Meters)
RG-8A/U	0.51 dB	2.53 dB	5.07 dB	10.14 dB
1/2 inch HELIAX	0.12 dB	0.76 dB	1.51 dB	3.02 dB
7/8 inch HELIAX	0.08 dB	0.42 dB	0.83 dB	1.66 dB
1-1/4 inch HELIAX	0.06 dB	0.31 dB	0.62 dB	1.24 dB
1-5/8 inch HELIAX	0.05 dB	0.26 dB	0.52 dB	1.04 dB

**Table 5. Signal Loss in Coaxial Cables (at 900 MHz)**

Cable Type	10 Feet (3 Meters)	50 Feet (15 Meters)	100 Feet (30.5 Meters)	200 Feet (61 Meters)
RG-8A/U	0.85 dB	4.27 dB	8.54 dB	17.08 dB
1/2 inch HELIAX	0.23 dB	1.15 dB	2.29 dB	4.58 dB
7/8 inch HELIAX	0.13 dB	0.64 dB	1.28 dB	2.56 dB
1-1/4 inch HELIAX	0.10 dB	0.48 dB	0.95 dB	1.90 dB
1-5/8 inch HELIAX	0.08 dB	0.40 dB	0.80 dB	1.60 dB

## 4.4 DC Power Connection

The transceiver may be operated from any well-filtered 10 to 30 Vdc power source. The supply must be capable of providing at least 2.5 Amperes continuously.

---

**NOTE:** Early SD4 models supported 10.5 to 16 Vdc power, not 10 to 30 Vdc. *Always check the labeling above the power connector to confirm the operating range for your unit.*

---

A power connector with screw terminals is provided with each unit (see Figure 16). Strip the wire leads to 6 mm (1/4 inch) and insert in the wire ports, tightening securely. Be sure to observe proper polarity as shown in Figure 16.

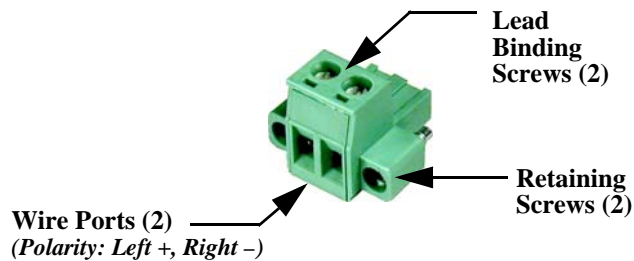

**Figure 16. DC Power Connector (P/N 73-1194A39)**

---

**NOTE:** The radio is designed for use in negative ground systems only.

---

## 4.5 Grounding Considerations

To minimize the chance of damage to the transceiver and connected equipment, a safety ground (NEC Class 2 compliant) is recommended which bonds the antenna system, transceiver, power supply, and connected data equipment to a *single-point* ground, keeping all ground leads as short as possible.

Normally, the transceiver is adequately grounded if the supplied flat mounting brackets are used to mount the radio to a well-grounded metal surface. If the transceiver is not mounted to a grounded surface, it is recommended that a safety ground wire be attached to one of the mounting brackets or a screw on the transceiver's case.

The use of a lightning protector is recommended where the antenna cable enters the building; bond the protector to the tower ground, if possible. All grounds and cabling must comply with applicable codes and regulations.

## 4.6 Ethernet Data Interface (RJ-45)

The transceiver's Ethernet Port is used to connect the unit to another Ethernet device. The port has built-in MDIX (auto-sensing) capability, allowing either a straight-through or crossover cable to be used. Figure 17 and Table 6 show pinout data for the Ethernet port. The Ethernet interface supports both radio management and payload data transport functions.

For radio management, connecting via a web browser provides enhanced functionality and ease-of-use over serial (COM1) methods or Telnet. Web-based management is the preferred and primary means of accessing the transceiver through the built-in *Device Manager*.

Telnet may also be used on this connector, and provides the same menu-based user interface available via COM1. If you wish to use Telnet for radio control, refer to the *SD Serial/Telnet Management Supplement*, Part No. 05-6193A01.

Various options are available for passing Ethernet data on this connector, allowing system administrators to optimize the configuration for maximum narrowband efficiency, based on the operating characteristics of their system.

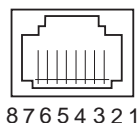

**Figure 17. Ethernet Port (RJ-45) Pinout**  
(As viewed from the outside of the unit)

**Table 6. Ethernet Port (IP/Ethernet) Pinouts**

Pin	Functions	Ref.
1	Transmit Data (TX)	High
2	Transmit Data (TX)	Low
3	Receive Data (RX)	High
4	Unused	

**Table 6. Ethernet Port (IP/Ethernet) Pinouts (Continued)**

Pin	Functions	Ref.
5	Unused	
6	Receive Data (RX)	Low
7	Unused	
8	Unused	

## 4.7 Serial Data Interfaces

COM1 and COM2 on the front panel serve as the serial interface ports for radio management and payload data, respectively. The following sections identify the pin functions used on each interface. These ports are user-configurable for specific applications. The procedures for changing their default operation are provided later in this guide.

---

**NOTE:** Not all PCs have a serial port. If one is not available, a USB-to-Serial adapter and appropriate driver software may be used to provide serial connectivity. These adapters are available from several manufacturers, including GE MDS.

---

### COM1 (Serial) Connection

The default factory settings for the radio's COM1 port (Figure 18) assigns it for management or diagnostics of the radio via a serial connection to a PC. COM1 may be used to set basic parameters such as output power, modem type and operating frequency of the radio, using text commands.

COM1 management provides an alternative to the web-based *SD Device Manager*, accessible via the Ethernet RJ-45 port (see Page 23) when Ethernet connectivity is not available. If you wish to use serial or Telnet control, refer to the *SD Serial/Telnet Management Supplement*, Part No. 05-6193A01.

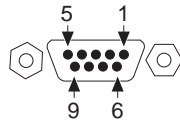

**Figure 18. COM1 Connector (DB-9F)**  
*As viewed from outside the unit*

For typical applications, a straight-through DB-9 cable may be used for PC management on COM1. If desired, a cable may be constructed as shown in Figure 19, using Pins 2 (RXD), 3 (TXD), and 5 (Ground). Table 7 lists all COM1 pins.



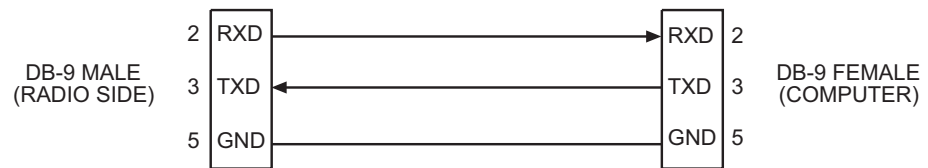

**Figure 19. COM1 Wiring for PC Management**

**Table 7. COM1 Pin Descriptions**

Pin Number	Radio Input/ Output	Pin Description
1	--	No function
2	OUT	<b>RXD (Received Data)</b> —Supplies received data to the connected device.
3	IN	<b>TXD (Transmitted Data)</b> —Accepts TX data from the connected device.
4	--	No function
5	--	<b>Ground</b> —Connects to ground (negative supply potential) on chassis.
6	--	No function
7	--	No function in most applications—User I/O for special applications
8	---	No function
9	--	No function in most applications—User I/O for special applications

### COM2 (Data) Connections

Typically, the COM2 port (Figure 20) is used for connecting the radio to an external DTE serial device supporting the RS-232 or RS-485 serial data format. The radio supports serial data rates of 300, 1200, 2400, 4800, 9600, 19200, 38400, 57600, and 115200 bps (asynchronous only).

#### **Pin Descriptions— RS-232 and RS-485**

Table 8 and Table 9 provide detailed pin descriptions for the COM2 data port in RS-232 mode and RS-485 modes, respectively.

**NOTE:** In addition to RS-485 mode, the radio is capable of operating in RS-422 mode. RS-485 must be selected in the menu, and the pin descriptions/wiring arrangements shown in Table 9 apply.

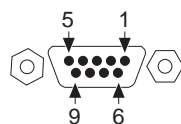

**Figure 20. COM2 Connector (DB-9F)**  
*As viewed from outside the radio*

**NOTE:** The radio is hard-wired as a DCE device.

**Table 8. COM2 Pin Descriptions—Radio in RS-232 Mode**

Pin Number	Radio Input/ Output	Pin Description
1	OUT	<b>DCD (Data Carrier Detect/Link)</b> —A high indicates signal received.
2	OUT	<b>RXD (Received Data)</b> —Supplies received data to the connected device.
3	IN	<b>TXD (Transmitted Data)</b> —Accepts TX data from the connected device.
4	IN	<b>Sleep Mode Input</b> —Grounding this pin places the radio in a low power consumption mode.
5	--	<b>Signal Ground</b> —Connects to ground (negative supply potential) on chassis.
6	OUT	<b>Alarm Output (DSR)</b> —Behavior is user-configurable. <i>Default behavior:</i> An RS-232 high/space (+5.0 Vdc) on this pin indicates an alarm condition. An RS-232 low/mark (–5.0 Vdc) indicates normal operation.
7	IN	<b>RTS (Request-to-Send)</b> —Keys the transmitter.
8	OUT	<b>CTS (Clear-to-Send)</b> —Goes “high” after the programmed CTS delay time has elapsed (DCE), or keys another connected radio when RF data arrives (CTS KEY).
9	--	Reserved—User I/O for special applications

**Table 9. COM2 Pin Descriptions—Radio in RS-485 Mode**

Pin Number	Input/ Output	Pin Description
1	OUT	<b>Carrier Detect/Link</b> —A high indicates signal received.
2	OUT	<b>TXD-/TXA (Transmitted Data -)</b> —Inverting driver output. Supplies received payload data to the connected device.
3	IN	<b>RXD-/RXA (Received Data -)</b> —Inverting receiver input. Accepts payload data from the connected device.
4	IN	<b>Sleep Mode Input</b> —Grounding this pin places the radio in a low power consumption mode.
5	--	<b>Ground</b> —Connects to ground (negative supply potential) on the radio’s PC board.
6	OUT	<b>Alarm Output</b> —Behavior is user-configurable. <i>Default behavior:</i> A high on this pin indicates an alarm condition; a low indicates normal operation.
7	IN	<b>RXD+/RXB (Received Data +)</b> — Non-inverting receiver input
8	OUT	<b>TXD+/TXB (Transmitted Data +)</b> —Non-inverting driver output.
9	--	Reserved—User I/O for special applications

**COM2 PORT NOTES:**

- RXD+ / RXB and RXD- / RXA are data sent to the radio to be transmitted
- RXD+ / RXB is positive with respect to RXD- / RXA when the line input is a "0"
- TXD+ / TXB and TXD- / TXA are data received by the radio and transmitted
- TXD+ / TXB is positive with respect to the TXD- / TXA when the line output is a "0"

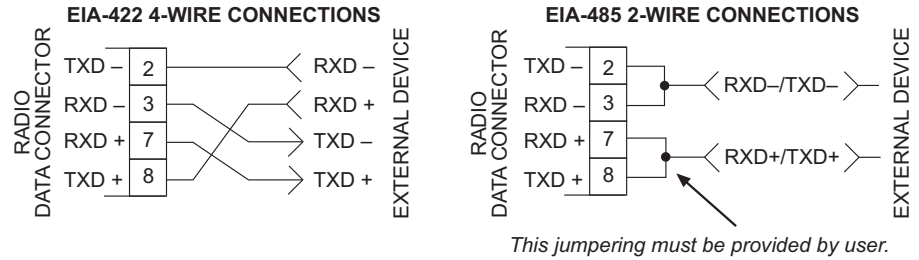

**Figure 21. RS-485 Wiring Arrangements**

## 5.0 STEP-BY-STEP INSTALLATION

In most cases, the steps given here are sufficient to install the transceiver. Refer to “INSTALLATION PLANNING” on Page 18 for additional details, as required.

1. **Mount the transceiver.** Attach the mounting brackets to the bottom of the transceiver case (if not already installed), using the three 6-32 x 1/4 inch (6 mm) screws supplied. Mounting bracket dimensions are shown in Figure 13 on Page 19. Secure the brackets to a flat, grounded surface. (If a grounded surface is not available, run a separate ground wire to the transceiver—see “Grounding Considerations” on Page 22.)
2. **Install the antenna and feedline.** The antenna used with the radio must be designed to operate in the radio’s frequency band, and be mounted in a location providing a clear path to the associated station(s). At Remote sites, aim directional antennas toward the Master unit. Low loss coaxial feedline should be used and it should be kept as short as possible.
3. **Connect the data equipment.** Connection may be made using IP/Ethernet signaling, Serial protocols (RS-232/RS-485), or both.
  - If an Ethernet device is to be used, connect it to the front panel ETHERNET port to the right of the PWR connector.
  - If a serial device is to be used, connect it to COM2 on the front panel. The radio is hardwired as a DCE device. A straight-through cable may be used in most applications.

---

**NOTE:** Do not connect the radio’s Ethernet port to a LAN with high traffic levels. Excessive traffic will overload the port and cause it to be temporarily disabled. In general, traffic levels above 4 Mbps are likely to cause port shutdown. (Traffic limit is less than 4 Mbps with packet sizes smaller than 64 bytes.)

---

4. **Connect primary power.** Input power must be within 10 to 30 Vdc and capable of providing at least 2.5 Amperes. (Note that some older SD4 radios only allow a 10.5 to 16 Vdc range. *Always verify the voltage range by checking the label above the power input socket.*)

A power connector with screw-terminals is provided with the unit (see Figure 16 on Page 22). Strip the wire leads to 1/4 inch (6 mm) and insert them into the wire ports. Be sure to observe proper polarity. Tighten the binding screws securely.



The unit is designed for use with negative-ground systems only. The power supply should be equipped with overload protection (NEC Class 2 rating), to protect against a short circuit between its output terminals and the radio's power connector.

5. **Configure Basic Settings.** Connect a PC to the radio's Ethernet connector. Access the radio's *Device Manager* through the PC's browser (default IP address is **192.168.1.1**). On a factory default radio, the *Device Manager* automatically starts the *Basic Setup Wizard* as seen in Figure 24 on Page 32. The wizard steps you through the essential radio settings in streamlined fashion. Detailed steps for starting configuration of the radio are presented in Section 5.1 below.

## 5.1 Initial Configuration

This section describes setup of the radio for its first on-air operation. A full description of operating settings is given in Section 6.0 on Page 36.

### Web-Based Management

The *Device Manager* is the recommended method for user management. It is a built-in software tool that works with your PC's browser to provide an intuitive, web-style presentation of all radio information, settings, and diagnostics.

The *Device Manager* also contains a "wizard" function to assist in setting up a radio with a minimum of user actions. Web management uses the radio's Ethernet RJ-45 connector. See "Web Browser Connection" on Page 30 for details.

Throughout Section 6.0 starting on Page 36, the following parameters may be shown in the example Figures. These may not be explicitly stated in the individual descriptions of the features, however, where they are applicable, the following is always true:

- **Commit Configuration**—Clicking this button causes any "staged" parameter changes to be activated and saved to non-volatile memory. Unlike most other attributes, terminal server attributes don't automatically "take" after making a change. Similar to the Ethernet settings, many items only make sense to change as a block, and this is why the **Commit Configuration** button is provided.
- **Refresh/Auto**—Clicking the **Auto** button causes the Web/UI interface to update and load the latest saved data. A configurable, periodic refresh update interval is provided for the **Auto** parameter. Clicking **Refresh** forces an instant update.

## Web Browser Connection

### Requirements

This section describes connection and use of the radio's built-in *Device Manager*. To connect to the radio and manage it via the *Device Manager*, you will need the following:

- A PC with a web browser program installed.
- An Ethernet cable connected between the PC and the radio as shown in Figure 22. (Alternatively, a network connection may be used, as long as the radio can be reached via its IP address.)
- The radio's IP address. Check with your Network Administrator, or determine the address via a serial/console connection (see **Starting Information Screen**). The default address for a factory supplied radio is **192.168.1.1**.
- The user name and password for the radio. Check with your Network Administrator, or, if a username and password have not been set, use the factory defaults of **admin** for both entries. (For security, a new password should be established as soon as possible after login.)

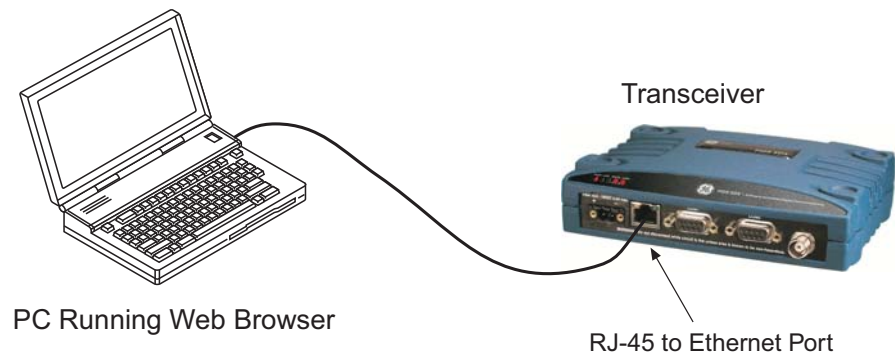

**Figure 22. PC Connection to Radio for Web Management**

### Logging On

1. Connect the radio to a PC via an Ethernet connection.
2. Configure your PC network settings to an IP address on the same subnet as the radio. The default subnet mask is **255.255.0.0**.
3. Enter the radio's IP address in a web browser window, just as you would enter a website address (<http://192.168.1.1>). When the login screen appears (Figure 23), enter the User Name and Password for the radio. The default entries for a new radio are both **admin**. Click **OK**.

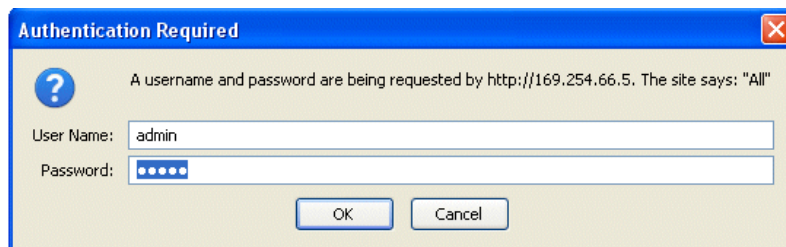

**Figure 23. Login Screen**

### **Using the Basic Setup Wizard**

4. The Basic Setup Wizard (Figure 24) begins automatically upon connection to a new factory shipped radio. It may also be started manually by selecting **Setup Wizards>>Basic Setup**, and then clicking **Start**. The Wizard displays a series of screens with key selections as follows:

- **TX/RX Frequencies**
- **System ID**
- **RF Output Power**
- **Radio Mode**
- **Modem Type (Transparent or Packet w/MAC)**
- **Com 2 Port Baud Rate**
- **Bridge Mode**
- **Encryption Mode**
- **DLINK Passphrase**
- **Device Type**
- **Ethernet Settings**

---

**NOTE:** TX and RX frequencies may not be set when the radio is shipped from the factory, depending on ordering options. If no frequencies have been set, an alarm condition is generated and the PWR LED flashes. These will be cleared after the frequencies are set. In *all* cases, users must verify that the frequencies are properly set according to the station license.

---

**NOTE:** Operation on exact multiples of 25 MHz is not supported by the SDx transceiver (*i.e.*, 400, 425, 450, 475, and 500 MHz).

---

**NOTE:** The option to configure the Radio Mode is also available under **Configuration >> Radio** under **Device Settings**.

---

Continue through each wizard screen until all selections have been made. (You may back up to previous screens if required, to review or change settings.) If you are unsure about a required setting, contact your Network Administrator for assistance.

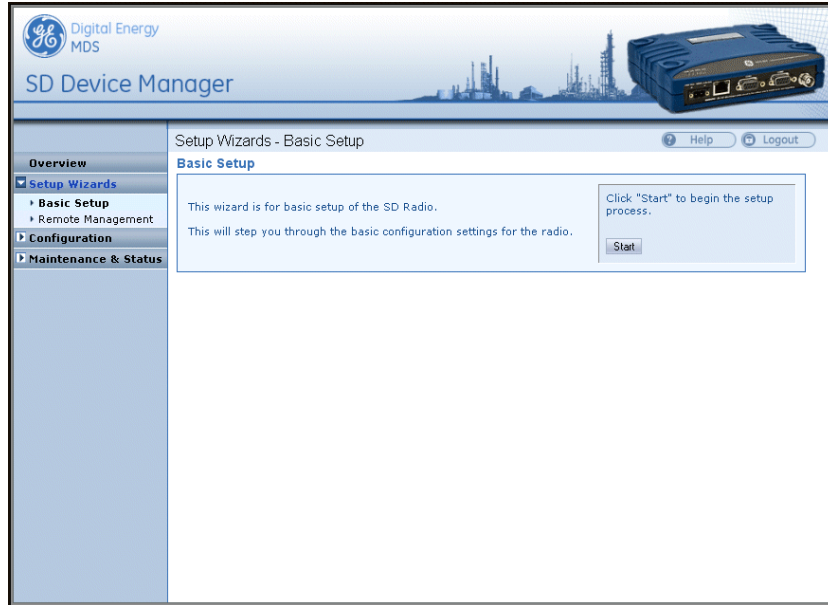

**Figure 24. Basic Setup Wizard**

- At the conclusion of the wizard, click **Done**. Configuration is now complete for the connected radio. Log out of the *Device Manager* by clicking **Logout** in the upper right hand side of the screen. If desired, you may proceed with the additional functions described below.

### **Using the Remote Management Wizard**

To program the key settings of Remote radios installed in the wireless network, select **Setup Wizards>>Remote Management** from the AP or Master Radio and follow the prompts contained in that tool. At the conclusion of the wizard, click **Commit Configuration**, followed by **Done**. Remote configuration is now complete.

### **Getting an Overview of Radio Settings**

To get a top-level view of the key settings and operating parameters for the radio, select **Overview** and a summary screen will be displayed. When finished, log out of the *Device Manager* by clicking **Logout** in the upper right hand side of the screen.

### **Alternative Management Methods**

The following methods are for use where web-based management is not available:

- **Serial**—(COM1 DB9 connector). This is the “console terminal” method of control commonly used on earlier GE MDS radios.
- **Telnet**—(ETHERNET RJ-45 connector). Telnet offers essentially the same capabilities as Serial control, but may be performed either through a local connection, or over a network.

For more information on alternative management methods, refer to the *SD Serial/Telnet Management Supplement*, Part No. 05-6193A01, available from the GE MDS website at [www.gemds.com](http://www.gemds.com).



## 5.2 Initial Startup & Checkout

In-service operation of the transceiver is completely automatic. Once the unit has been properly installed and configured as described above, operator actions are limited to observing the front panel LED indicators for proper operation.

If all parameters are correctly set, operation of the radio can be started by following these steps:

1. Apply DC power. Unit must be powered on
2. Observe the LED status panel for proper indications (Table 10).
3. If not done earlier, refine the antenna heading of the station to maximize the received signal strength (RSSI) from the Master Unit. The **Maintenance & Status>>Performance** screen may be used to observe RSSI. Turn the antenna heading slowly so that the RSSI display can be updated.

---

**NOTE:** The RSSI facility limits the maximum displayed signal strength to  $-60$  dBm. Signal levels that are higher than  $-60$  dBm will appear as  $> -60$  dBm.

---



**Table 10. LED Status Indicators**

LED Name	Description
<b>PWR</b>	<ul style="list-style-type: none"> <li>• Continuous—Power applied, no problems detected.</li> <li>• Rapid flash (5 times-per-second)—Alarm indication, or RX/TX frequencies not set.</li> </ul>
<b>LAN</b>	<ul style="list-style-type: none"> <li>• Flashing—Data is being transmitted and received.</li> <li>• Off—Ethernet signals not detected</li> </ul>
<b>DATA1 / DATA2</b>	These LEDs show data activity on the DB-9 serial payload ports (COM1/COM2).
<b>LINK</b>	When lit, indicates that a communication link exists with the Master Unit.

### Ethernet Connector LEDs

The 10/100 Base-T Ethernet connector has two embedded LEDs. A flashing green indicator shows data activity, and a yellow indicates 100 Mbps operation has been achieved.

## 5.3 Optimizing the Radio Network

With basic configuration complete, there are several additional settings that can be made to optimize the radio system. The settings below should be reviewed and changed as necessary to suit your particular application.

### Modem Type Setting

All radios in the network must be set to the same modem type and speed. A range of values is available. The default setting is **9600**. This setting may be set/viewed using the **Configuration>>Radio>>Basic Settings** screen. See Page 43 for details.

In general, the higher the modem baud rate, the faster the communication speed over the air. However, it must be remembered that signal strength also plays a role in how fast a transmission may be sent. If signals are strong, faster speeds are possible. If signals are fair or poor, slower speeds may be needed to achieve the best communication results with the least number of re-transmissions due to errors.

### Inter-Packet Gap Settings

For radios operating in Packet Mode, the inter-packet gap is a timing setting used to delimit a packet on the serial interface. Too short of a time can cause serial streams to be combined into one large packet instead of two smaller ones. Too long of a time can slow down the communications channel.

Inter-Packet Gap Settings for COM1 and COM2 are made using the **Configuration>>Radio>>Packet Settings** window. See Page 48 for details.

### Baud Rate Setting

The higher the baud rate, the faster the communication speed of the serial link connected to the COM port. However, this setting has no direct effect on over-the-air transmission speed.

The modem baud rate is set using the **Configuration>>Communication Ports>>COM1/2 Port Settings** window. See Page 67 for details.

---

**NOTE:** Baud rate settings that are matched or higher than the modem speed should be used in all cases. If the baud rate must be lower than the modem speed, the **Data Key Hold Time-out** can be adjusted. See “Data Key Hold Time-out” located on Page 54.

---

## Ethernet Settings

The local Ethernet connection must be configured to conform to the needs of the local Ethernet network. The **Configuration>>Communication Ports>>IP/IP2 Configuration** screen is used to set/view these settings. Here are some general points that apply to Ethernet settings:

- The radio's Ethernet settings must be configured in order to communicate over the LAN to which it is connected.
- It must be known whether or not a DHCP server is active in a network to make use of the radio's DHCP client setting.
- If a DHCP server is available, DHCP client can be enabled on the radio. Once enabled, it can take a few minutes before the radio obtains an IP address, which will be displayed in the **Current IP Address** field.
- If DHCP operation is unavailable (or is not desired), then a static IP address may be manually set. IP network setup is beyond the scope of this manual. Consult your network administrator.
- As a quick reference, a typical LAN setup might appear as follows:

<b>Static IP Address</b>	<b>192.168.1.101</b>
<b>Static IP Netmask</b>	<b>255.255.255.0</b>
<b>Static Default Gateway</b>	<b>192.168.1.1</b>
<b>DHCP</b>	<b>Disabled</b>

See Page 69 for more information on Ethernet settings.

## Antenna SWR Check

Before placing the radio into final service, a check should be made of the antenna system's standing wave ratio (SWR). Use a directional wattmeter suited to the frequency of operation for this check. High SWR (above 2:1) may indicate an antenna, connector, or feedline problem, and should be corrected.

## 6.0 USING THE DEVICE MANAGER

The radio contains a built-in management system known as a *Device Manager*. This web-based tool is accessed with a PC connected to the radio's Ethernet port as shown in Figure 25. It offers an intuitive method for managing your radio and performing common maintenance tasks.

---

**NOTE:** The *Device Manager* is the preferred method for managing the transceiver. Menu-based Serial or Telnet management is also possible. Refer to the *SD Serial/Telnet Management Supplement*, Part No. 05-6193A01 for details.

---

If you are using the *Device Manager* for the first time, refer to “Web Browser Connection” on Page 30 for instructions on connecting a PC to the radio and logging into the *Device Manager* for basic radio setup, including use of the Setup Wizards.

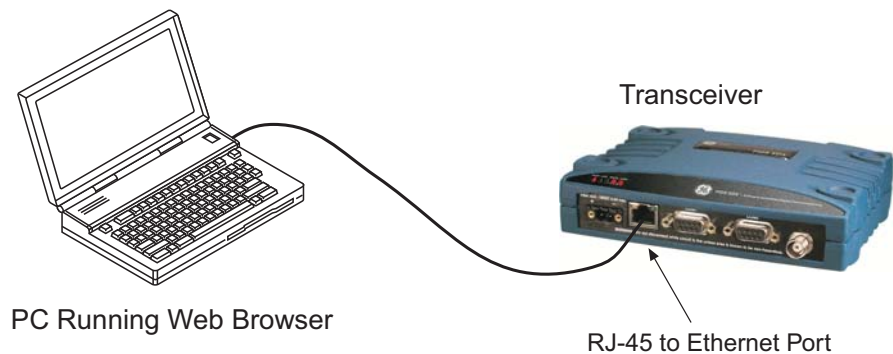
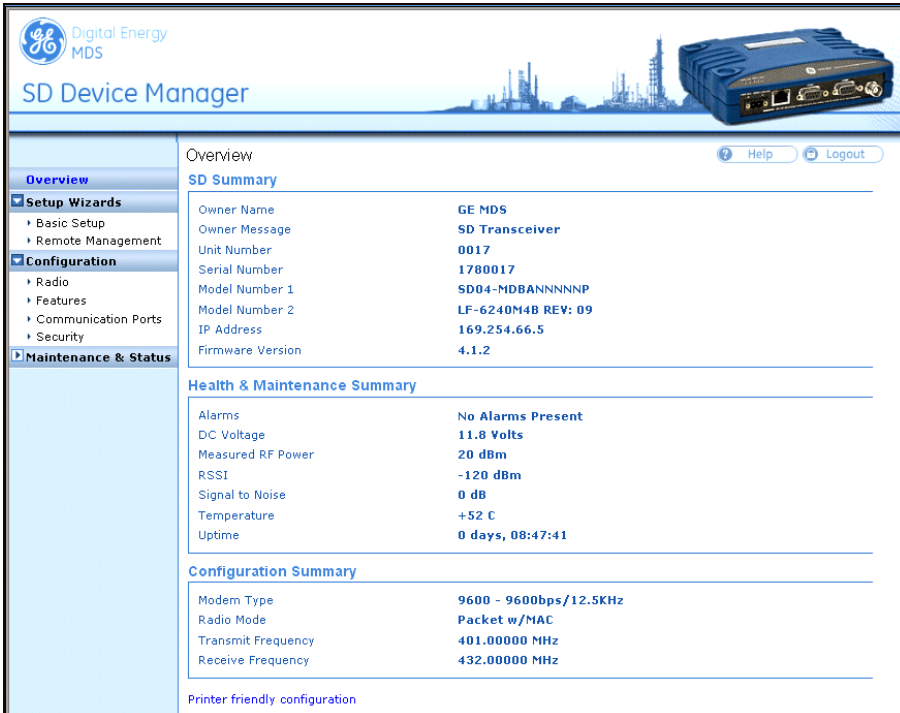

**Figure 25. PC Connection to Radio for Web Management**

### 6.1 Navigating the Screens

Upon login to the *Device Manager*, the **Overview** screen appears as shown in Figure 26. The selection pane at the left side of this screen provides access to any of the available screens. Simply click an item of interest, and the new screen appears. Sub-level screens are displayed under the main heading, and may be clicked to open them.

With a desired screen displayed, simply scroll up or down to reach a required setting or indication. Drop-down boxes or blank fields are provided for entering new information. Once a new parameter is entered, click **Commit Configuration** on the right-hand side of the screen to apply the setting, or select **Undo** to cancel it.



**Figure 26. Overview Summary Screen**

## Overview Screen

The **Overview** screen (Figure 26) provides a read-only view of all key settings and operating conditions for the radio. The **Health & Maintenance Summary**, in particular, can help you quickly spot changes in operating conditions. By becoming familiar with expected readings, you can identify parameters that are outside their normal ranges, and take corrective action.

### **Printout Option**

Clicking the **Printer friendly configuration** label at the bottom of the screen brings up a print-ready report that includes not only the **Overview** screen, but *all* settable items and indications. Printing this report and keeping it with the manual provides a convenient way of reviewing the settings for a particular unit at any point in the future.

### **Logging Out**

To exit the *Device Manager*, click **Logout** in the upper right hand side of any screen. The session is terminated.

---

**NOTE:** To maintain security, it is best to log-out of the *Device Manager* as soon as you are done working with it. If you do not log out, the session automatically ends after 10 minutes of inactivity.

---

## 6.2 Management Tasks

Table 11 shows a listing of commonly-needed tasks and the appropriate sections of the *Device Manager* to refer to. The table can be used as a quick reference before consulting the more detailed screen information which follows in this section.

**Table 11. Device Manager Quick Reference**

<b>Task Category</b>	<b><i>If you wish to...</i></b>	<b><i>Refer to this Screen/Section</i></b>
<b>View Overall Status &amp; Performance Information</b>	View top-level unit information (Owner Name/Message, Unit Number, IP Address, Serial No., Firmware version, Run time, Alarm presence, etc.)	<b>Overview, Page 37</b>
	View Radio Performance data (Power Output, Signal-to-Noise Ratio, Received Signal Strength, DC Input voltage, operating temperature)	<b>Maintenance &amp; Status&gt;&gt; Radio Performance, Page 75</b>  <b>Or: Overview&gt;&gt; Health &amp; Maintenance Summary (shows uptime), Page 37</b>
	View Serial No., Model 1 (software), Model 2 (hardware) version, Firmware Version, Build Date	<b>Overview&gt;&gt; SD Summary, Page 37</b>
	View Bootloader version information, Active Firmware Image, Firmware Version level	<b>Maintenance &amp; Status&gt;&gt; Firmware Utilities&gt;&gt; Version Information, Page 81</b>
	View Alarm/Event information, I/O Statistics, Ethernet Statistics	<b>Maintenance &amp; Status&gt;&gt; Alarm Summary, Page 74</b>  <b>Maintenance &amp; Status&gt;&gt; Performance, Page 75</b>

**Table 11. Device Manager Quick Reference (Continued)**

<b>Task Category</b>	<b><i>If you wish to...</i></b>	<b><i>Refer to this Screen/Section</i></b>
<b>View/Set Radio (RF) Operating Parameters</b>	Set RF Output Power, Modem Type, RX/TX Frequency	<b>Configuration&gt;&gt;Radio, Basic Settings, Page 43</b>
	View/Set Soft-Carrier Dekey status, RX/TX Time-Out options	<b>Configuration&gt;&gt;Radio&gt;&gt;Advanced Settings, Page 53</b>
	View/Set Data-Key and RTS-Key settings (ON/OFF)	<b>Configuration&gt;&gt;Radio&gt;&gt;Advanced Settings, Page 53</b>
	View/Set Push-to-Talk/Clear-to-Send Delay times (ms)	<b>Configuration&gt;&gt;Radio&gt;&gt;Advanced Settings, Page 53</b>
	View/Set Automatic Frequency Correction (AFC) setting	<b>Configuration&gt;&gt;Radio&gt;&gt;Advanced Settings, Page 53</b>
	View/Set Switched Carrier ON/OFF setting (B Modems)	<b>Configuration&gt;&gt;Radio&gt;&gt;Advanced Settings, Page 53</b>
	Configure Listen-Before-Transmit (LBT) collision avoidance	<b>Configuration&gt;&gt;Features&gt;&gt;LBT Settings, Page 57</b>
	View Received Signal Strength (RSSI) level	<b>Maintenance &amp; Status&gt;&gt;Performance, Page 75</b>
	Key the radio transmitter, view power output	<b>Maintenance &amp; Status&gt;&gt;Radio Test&gt;&gt;RF Keying Test, Page 79</b>
	View local radio emissions to locate possible interference sources.	<b>Maintenance &amp; Status&gt;&gt;Radio Test&gt;&gt;Spectrum Graph, Page 79</b>

**Table 11. Device Manager Quick Reference (Continued)**

<b>Task Category</b>	<b><i>If you wish to...</i></b>	<b><i>Refer to this Screen/Section</i></b>
<b>View/Set Device Configuration</b>	View Serial No., Model 1 (software), Model 2 (hardware) version, Firmware Version, Build Date	<b>Overview&gt;&gt; SD Summary, Page 37</b>
	Set Owner Name/Message, enable/disable Sleep Mode, set COM LED mode, Radio Mode	<b>Configuration&gt;&gt; Radio&gt;&gt;Device Settings, Page 46</b>
	Configure time delays to identify packets on serial ports	<b>Configuration&gt;&gt; Radio&gt;&gt; Packet Settings, Page 48</b>
	Configure Media Access Control (MAC) settings	<b>Configuration&gt;&gt; Radio&gt;&gt; Media Access Control&gt;&gt; Settings, Page 48</b>
	Configure Store and Forward (SAF)	<b>Configuration&gt;&gt;Radio&gt;&gt; Media Access Control&gt;&gt;Page 48</b>
	Configure Virtual LAN (VLAN)	<b>Configuration&gt;&gt;Features&gt;&gt; VLAN Config., Page 55</b>
	Configure Terminal Server 1/2	<b>Configuration&gt;&gt;Features&gt;&gt; Term Srvr COM1/2 Config., Page 61</b>
	View Unit ID and/or DLINK diagnostics settings	<b>Configuration&gt;&gt; Radio&gt;&gt; Diagnostic Settings, Page 52</b>
<b>Security Settings</b>	Set Password for radio	<b>Configuration&gt;&gt; Security&gt;&gt; Login Password, Page 71</b>
	Set Device Security (enable/disable local login requirement, enable/disable Telnet access, enable/disable web access)	<b>Configuration&gt;&gt; Security&gt;&gt; Device Security, Page 70</b>
	Set Wireless Security parameters (Encryption on/off, DLINK Security on/off, Encryption Phrase, DLINK Encryption Phrase)	<b>Configuration&gt;&gt; Security&gt;&gt; Wireless Security, Page 71 Configuration&gt;&gt; Security&gt;&gt; Encryption Phrase, DLINK Encryption Phrase, Page 72</b>
<b>IP Payload Configuration</b>	Configure the IP settings (Static IP Address, Static IP Netmask, Static Default Gateway, DHCP enable/disable, Virtual Radio Channels–VRCs)	<b>Configuration&gt;&gt; Communication Ports&gt;&gt; IP Configuration, Page 69</b>
	Configure Ethernet Bridging, enable/disable Bridge Filtering	<b>Configuration&gt;&gt; Features&gt;&gt; Bridge Configuration, Page 55</b>
	Configure the IP Payload settings (Enable/disable port, set mode, Local IP Port, Destination IP Address, Destination IP Port)	<b>Configuration&gt;&gt; Features&gt;&gt;IP Payload 1, 2, 3, Page 58</b>



**Table 11. Device Manager Quick Reference (Continued)**

<b>Task Category</b>	<b><i>If you wish to...</i></b>	<b><i>Refer to this Screen/Section</i></b>
<b>Serial Port Configuration</b>	Configure COM1 settings (Startup mode, Data Baud Rate, Data format, Virtual Radio Channels–VRCs)	<b>Configuration&gt;&gt; Communication Ports&gt;&gt; COM1 Port Settings, Page 67</b>
	Configure COM2 settings (Mode, Baud Rate, Format, Buffer on/off, Device Type, Virtual Radio Channels–VRCs)	<b>Configuration&gt;&gt; Communication Ports&gt;&gt; COM2 Port Settings, Page 68</b>
<b>Transceiver Maintenance and Diagnostic Tests</b>	View Radio Performance data (Power Output, Signal-to-Noise Ratio, Received Signal Strength, DC Input voltage, operating temperature)	<b>Maintenance &amp; Status&gt;&gt; Performance&gt;&gt; Radio Performance, Page 75</b>
	Perform radio tests (Radio Keying, show Spectrum Graph, run RTU Simulator)	<b>Maintenance &amp; Status&gt;&gt; Radio Test, Page 77</b>
	View Bootloader version information, Active Firmware Image, Firmware Version level	<b>Maintenance &amp; Status&gt;&gt; Firmware Utilities&gt;&gt;Version Information, Page 81</b>
	Locally Reprogram the Transceiver via TFTP transfer	<b>Maintenance &amp; Status&gt;&gt; Firmware Utilities&gt;&gt;TFTP Reprogramming, Page 82</b>
	Broadcast Remote Configuration settings to <i>all</i> radios in the network	<b>Setup Wizards&gt;&gt;Remote Management, Page 32</b>
	Work with Configuration Files... –Restore Factory default configuration –Save/restore user configuration –View/restore key configuration parameters –Save/load key configuration parameters using file transfer (TFTP)	<b>Maintenance &amp; Status&gt;&gt; TFTP Configuration File, Page 85</b>
	Start radio network reprogramming (and monitor progress)	<b>Maintenance &amp; Status&gt;&gt; Firmware Utilities&gt;&gt; Remote Reprogramming, Page 82</b>
	Perform Ethernet PING to local Ethernet host	<b>Maintenance &amp; Status&gt;&gt; Radio Test&gt;&gt;Ping Test, Page 78</b>
	Test communications to specific Remote radio	<b>Maintenance &amp; Status&gt;&gt; Radio Test&gt;&gt;Link Test, Page 78</b>
	Enter a Factory Authorization code, or view currently enabled features	<b>Maintenance &amp; Status&gt;&gt; Firmware Utilities&gt;&gt; Authorization Codes, Page 84</b>
	View active Alarms	<b>Maintenance &amp; Status&gt;&gt; Alarm Summary, Page 74</b>

**Table 11. Device Manager Quick Reference (Continued)**

Task Category	If you wish to...	Refer to this Screen/Section
<b>Transceiver Maintenance and Diagnostic Tests (Cont'd)</b>	View logged Events	<b>Maintenance &amp; Status&gt;&gt; Event Log, Page 73</b>
	Set alarm signal output (active high/low)	<b>Maintenance &amp; Status&gt;&gt; Alarm Summary&gt;&gt; Alarm Signal Configuration, Page 74</b>
	Conduct an Alarm Test	<b>Maintenance &amp; Status&gt;&gt; Radio Test&gt;&gt; Alarm Test, Page 80</b>
	View I/O Statistics for COM1, COM2, Ethernet Port, Remote Programming, Ethernet Interface, Data Link Layer, and MAC.	<b>Maintenance &amp; Status&gt;&gt; Performance&gt;&gt; I/O Statistics, Page 76, and Ethernet Statistics, Page 76</b>
	View MAC Routes	<b>Maintenance &amp; Status&gt;&gt; Performance&gt;&gt; MAC Routes, Page 77</b>

The remainder of this section covers the screens for **Configuration**, and **Maintenance and Status** of the transceiver. The emphasis is on available selections, how to access them, and their effect on radio operation. If you are unsure of the setting required for a particular radio in your network, consult your Network Administrator for assistance.

---

**NOTE:** The *Device Manager* screens shown in this manual were obtained from a radio operating in a lab environment and are provided as examples only. Not all content will be legible in these reduced size examples. Also, the parameters and settings shown may differ from those seen in field service conditions.

---

## 6.3 Configuration Screens

The **Configuration** screen (Figure 27) contains a number of key settings for the radio, including RF parameters, modem selection, packet settings, MAC parameters, and several advanced settings. Individual screens may be selected beneath **Configuration** on the left side of the screen.

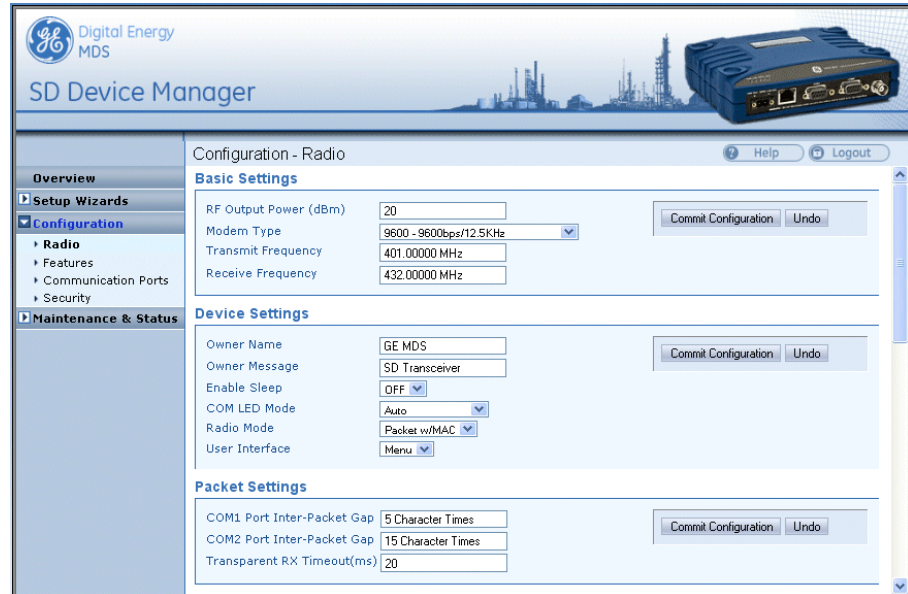
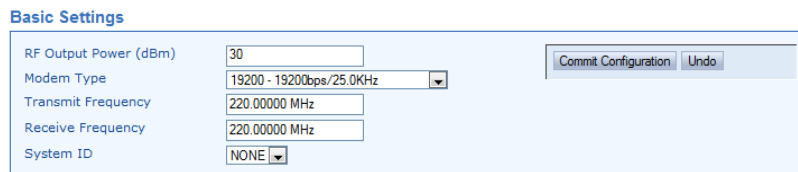

**Figure 27. Configuration Screen**  
(Portion of screen shown—scroll for additional selections)

### Radio

#### **Basic Settings**

The **Basic Settings** screen contains important RF and modem selections for radio operation.



- **RF Output Power (dBm)**—The RF output power may be set between 20 and 37 dBm (0.1 to 5 watts) in 1 dB increments. The default setting is 37 dBm. Full power is not required in many cases, and lower settings will place less demand on the DC power supply and reduce the chance of interference with other stations. Only the power necessary to carry out reliable communications should be used.
- **Modem Type**—This setting determines the over-the-air data speed and bandwidth of the radio’s transmitted signal. All radios in the network must use the same modem setting to communicate with each other. The default setting is **Modem 9600**, but it may be set to

any of the selections shown in Table 12. The table also lists modem sensitivity ratings for the various modems. Note that some modem choices are limited based on the model purchased.

**Table 12. Modem Selection vs. Speed, Bandwidth & Sensitivity**

Modem Type Selection	Over-the-air Speed (bps)	B/W (kHz)	Approximate Sensitivity <sup>4</sup>	ETSI Compliance
Modem 9600 <sup>1</sup>	9600	12.5	-112 dBm	
Modem 4800 <sup>1</sup>	4800	12.5	-112 dBm	X
Modem 3200 <sup>1, 2</sup>	3200	5.00	-108 dBm	
Modem 9600M <sup>1</sup>	9600	12.5	-106 dBm	X
Modem 4800F	4800	6.25	-108 dBm	
Modem 9600B <sup>1</sup>	9600	12.5	-106 dBm	
Modem 4800B <sup>1</sup>	4800	12.5	-110 dBm	
Modem BELL <sup>1</sup>	1200	12.5	-110 dBm	
Modem V23	1200	12.5	-110 dBm	
Modem 19200N	19200	12.5	-100 dBm	
Modem 19200E	19200	12.5	-96 dBm	X
Modem 9600N	9600	6.25	-98 dBm	
Modem 19200	19200	25.0	-105 dBm	
Modem 38400N	38400	25.0	-99 dBm	
Modem 65000 <sup>3</sup>	65000	50.0	See note 3	
Modem 19200M	19200	25.0	-106 dBm	X
Modem 38400E	38400	25.0	-97 dBm	X

1) For MDS x710-compatible operation.

2) 3200 bps not applicable to SD4.

3) Only available for SD2 and SD9 units with wide bandwidth hardware option.  
Approximate sensitivity is -104 dBm for SD2 and -95 dBm for SD9.

4) SD1 sensitivity may be up to 2 dB less, due to MDS 1710 interoperability constraints.

- **Transmit/Receive Frequency**—The receive and transmit frequencies may be viewed or set here. If no frequencies have been entered, the fields will be blank and the radio's PWR LED will flash, indicating that an entry is needed. Frequencies *must* be entered for the radio to operate. Consult your station license to determine the authorized frequencies for your system, and enter them exactly as listed.

- System ID**—Provides the possibility for Frequency Re-use. SysID offers nine unique choices including the default value of **NONE**. The setting **NONE** is required for mixed networks comprised of MDS legacy and SDx products. SDx-only networks can utilize the Frequency Re-use feature by setting the System ID to a common value [1-8] for all radios in a specific network. SysID (or System ID as it is referred to in the Device Manager) offers approximately 20 dB of additional co-channel isolation when operating networks on the same frequency. Note that proper system design is required.

Operational Example: SDx System “Alpha” has eight units and SDx System “Beta” has eight units. A user wishes to occupy frequency 952.1235 MHz on both of these systems. Proper system installation has been adhered to in both networks. System Alpha’s units would all be set to **System ID = 1**, System Beta’s units would be set to **System ID = 5**. Both systems will now operate on the same desired frequency.

Examples of valid and invalid arrangements are shown Figure 28 and Figure 29, respectively.

**NOTE:** All radio sites must adhere to proper RF installation techniques. This is especially important for System ID arrangements. Contact your factory representative if additional guidance is required.

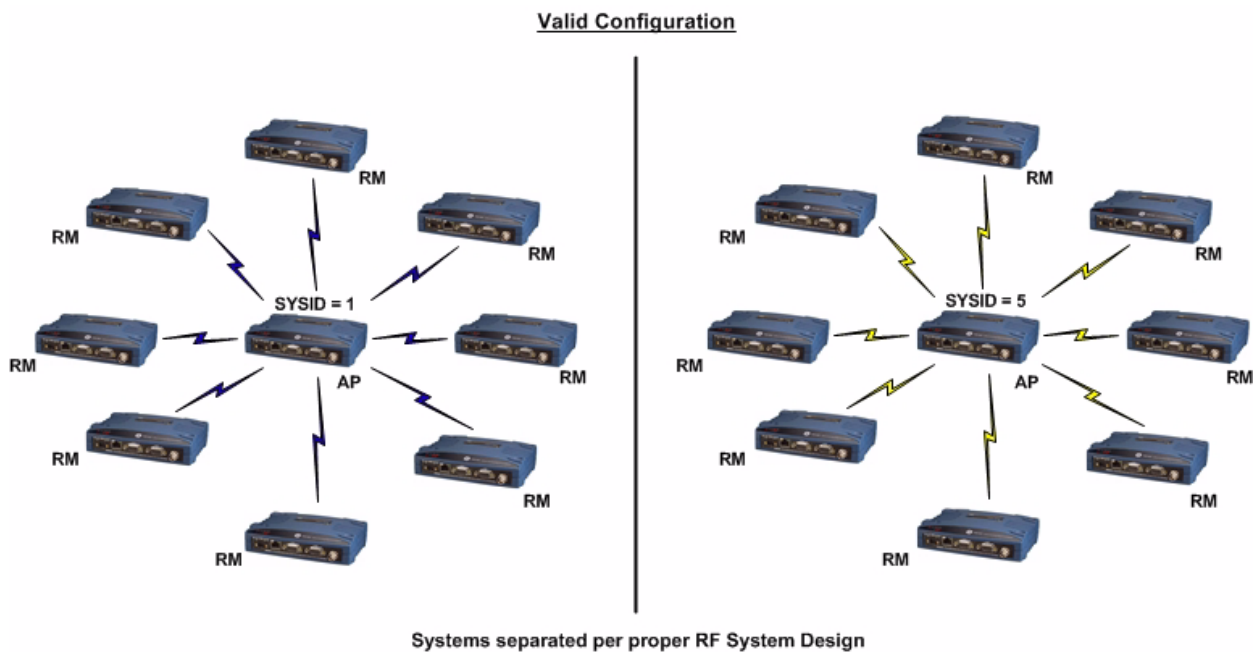

**Figure 28. System ID Example—Valid Arrangement**

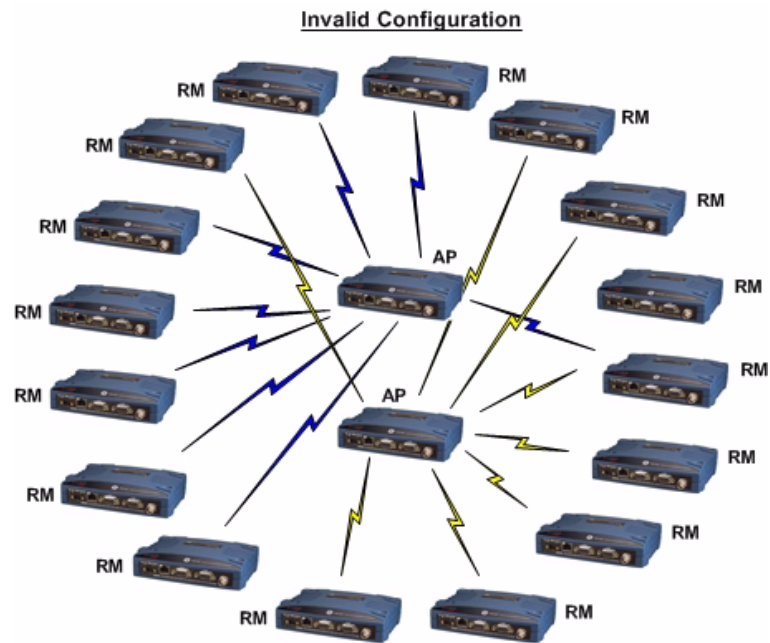

**Figure 29. System ID Example—Invalid Arrangement**  
*(Will not operate properly with SD Transceivers)*

## Device Settings

Device Settings	
Owner Name	<input type="text" value="GE MDS"/>
Owner Message	<input type="text" value="SD Transceiver"/>
Enable Sleep	<input type="button" value="OFF"/>
COM LED Mode	<input type="button" value="Auto"/>
Radio Mode	<input type="button" value="Packet w/MAC"/>
User Interface	<input type="button" value="Menu"/>

- Owner Name/Owner Message**—An owner name and message may be entered for the radio for informational purposes. These are “free-form” fields which do not affect the operation of the radio in any way. Such fields might be used to identify the network administrator/company name, and include a site-specific message (*i.e.*, Unit 2 at North Tower site). Up to 30 alpha-numeric characters may be entered (there is no minimum), and any printable characters may be used.
- Enable Sleep**—Sleep Mode places the transceiver into a “hibernated” low power state, with a nominal current draw of less than 12 mA (at 13 Vdc). “Wake-up” time is approximately 50 milliseconds. Sleep Mode is often used at battery/solar-powered remote sites to conserve power. An active low on Pin 4 of the

COM2 port is what actually puts the radio to sleep. This signal must be supplied by the equipment connected to the radio (*i.e.*, RTU, PLC, etc.). Sleep mode is not intended for use on Master radios.

- **COM LED Mode**—The behavior of the radio’s COM/DATA LEDs may be configured using this box. By default, the LEDs show dual port activity (**Auto**). Four LED modes may be selected as summarized in Table 13.

**Table 13. COM/DATA LED Modes vs. Behavior**

LED Mode Selection	Serial COM/DATA LED Behavior	
	LED1 Function	LED2 Function
x710	Monitors TXD on COM2 port	Monitors RXD on COM2 port
COM1 Activity	Monitors any COM1 RX or TX activity	OFF
COM2 Activity	OFF	Monitors any COM2 RX or TX activity
Dual Port Activity ( <b>Auto</b> Default)	Monitors any COM1 RX or TX activity	Monitors any COM2 RX or TX activity

- **Radio Mode**—The radio can operate in one of several modes. The available selections are:
  - Packet - with and without AES Encryption
  - Packet w/MAC - with and without AES Encryption
  - x710 (not covered by this manual; See pub. 05-4670A01)
  - Transparent - with and without AES Encryption. (Transparent w/AES Encryption requires an all SD radio network.)
- **User Interface**—This parameter selects the method of radio management for the Serial/Telnet interface. It has *no effect* on the web interface. The default selection is **Menu**. Alternatively, you may select **CLI**, which switches the radio to a Command Line Interface. With this interface, commands are entered in text-based fashion, as described in the *SD Serial/Telnet Management Supplement*, Part No. 05-6193A01.

## Packet Settings

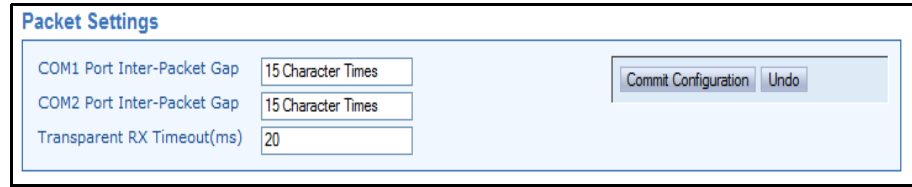

Packet Settings	
COM1 Port Inter-Packet Gap	15 Character Times
COM2 Port Inter-Packet Gap	15 Character Times
Transparent RX Timeout(ms)	20

- COM1/COM2 Port Inter-Packet Gap**—Timing setting used to delimit a packet on the serial interface for radios operating in Packet Mode. Too short of a time can cause serial streams to be combined into one large packet instead of two smaller ones. Too long of a time can effectively slow down the communications channel. The Inter-Packet Gap is specified by the number of character times (the time it takes to send an individual character).
- Transparent RX Timeout (ms)**—This setting is similar to the timing parameters for **COM1/COM2 Inter-Packet Gap**, but it applies to data received *over-the-air*. It tells the radio how to build an Ethernet packet based on a transparent data stream received over the radio channel.

## Media Access Control (AP menu shown)

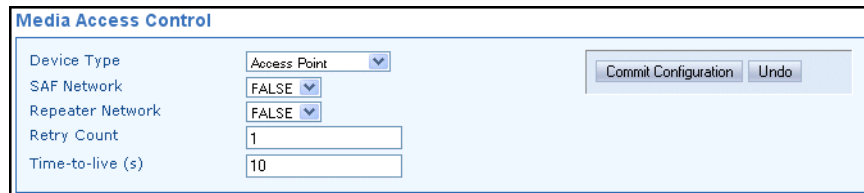

Media Access Control	
Device Type	Access Point
SAF Network	FALSE
Repeater Network	FALSE
Retry Count	1
Time-to-live (s)	10

- Device Type**—Selects **Access Point**, **Remote**, or **Store and Forward**. An **Access Point** serves as the Controller of the RF network. Only one radio is configured as an AP. Typically this is the “polling master.” A **Remote** is connected to end devices in the field (*e.g.* PLC, RTU), and there can be any number of these in a network. Each Remote must have a unique Unit Address, which is set on



the **Diagnostic Settings** screen (see “Diagnostic Settings” on Page 52). A Store and Forward device is a radio designated to retransmit data to/from an outlying Remote (see SAF Network, below).

- **SAF Network**—(AP Only) Selects whether or not a Store and Forward radio is present in the network (**True**), or not (**False**). Store and Forward extends the coverage area of a network beyond the primary “footprint” of the system. This can be used to link outlying Remotes (or Remotes blocked by terrain or other obstructions) into the network. A detailed discussion on using Store and Forward is provided below.
- **Repeater Network**—(AP Only) This setting must be enabled if the RF network contains a repeater station, or communications will not work. Remotes automatically learn this setting from the AP.
- **Retry Count**—If a message is not acknowledged after transmission it will be resent. This value controls how many times the radio attempts to resend the message before discarding it.
- **Time-to-Live (s)**—When a message arrives from the payload interface(s) it is time-stamped and queued for radio transmission. If the radio cannot transmit the message before the Time-to-Live (TTL) value, the message is discarded. This helps prevent stale or old data from being sent over the air.

## Store and Forward Operation

Store and Forward (SAF) operation extends a wireless network’s coverage area by electing a device (or devices) to store data and forward it to a unit (or units) beyond the reach of the primary coverage area. Conventional RF repeaters receive and transmit data simultaneously. They are effective at increasing range with low latency, but they are more expensive, have high power consumption, and require more complex installation. SAF-designated units act as smart single radio packet repeaters. The SAF feature provides a simple, low cost alternative to range extension when a traditional repeater isn’t desired.

Figure 30 on Page 50 depicts a typical single unit SAF network. This network supports a *single* SAF hop. Chained SAF hops are not allowed. However, multiple SAF radios are supported provided their RF coverage areas do not overlap, as this would create radio interference and severely reduce throughput. SAF will work in conjunction with repeater assemblies to provide even more extended range.

---

**NOTE:** Remote radios being served by a Store-and-Forward unit must have their TX/RX frequencies set to match those of the AP/Master station. This allows communication with the SAF radio, which uses standard Remote TX/RX frequencies.

---

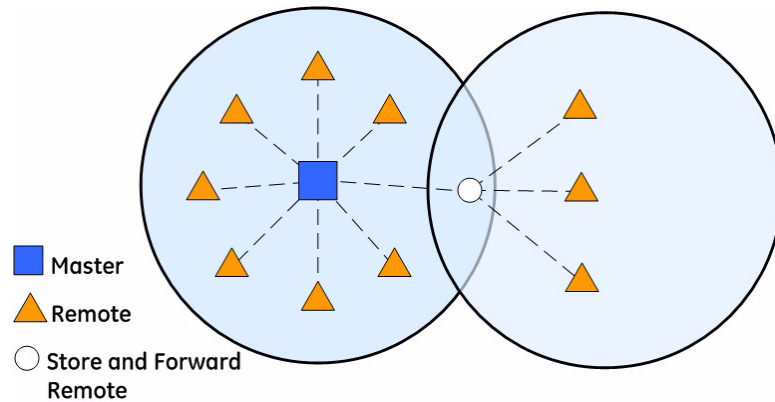

**Figure 30. Store and Forward System Example**

Store and Forward is available in Packet w/MAC mode and supports all MAC features including collision avoidance, retries, and acknowledgements. Furthermore, all major radio features are supported in SAF networks such as diagnostics, over the air programming, bridging, VRCs, etc.

**Dual Duty of SAF Remotes:** Since a SAF device doubles as a Remote radio it may participate in direct exchanges with the Master/AP. By design, an SAF device is always within the primary coverage area and has direct communication to the Master/AP. Therefore, all SAF devices act as both a standard Remote for direct exchanges, as well as an SAF unit for Store and Forward exchanges. A SAF exchange is defined as any exchange between the Master/AP and a Remote through an SAF device. In all cases, the Master/AP still controls the operation of the network.

After sending a SAF data frame, the Master/AP remains idle until the frame has been delivered to the Remote, at which time it will return to direct or SAF operation, depending on the message type (unicast or broadcast).

**Direct vs. SAF Traffic:** Depending on network topology, it is possible for some Remotes to hear both direct polls from the Master/AP and SAF messages from an SAF-designated Remote. It is more desirable to use the direct traffic to avoid the latency of going through the SAF link, and the radio's firmware handles this situation automatically. SAF frames are ignored when the direct path is available. The system is dynamic; if the direct path becomes unavailable for any reason, it quickly switches to the SAF path to provide continued operation.

**Traffic Routing:** Typically, network radios are immobile, but fading may cause paths to come and go. Because of this, the Master/AP device implements *routing* to each Remote device. This ensures that only SAF traffic passes through SAF Remotes. Direct traffic is terminated at the local coverage area, keeping efficiency high. The transceiver achieves these steps automatically, and does not require user input. The following is an explanation of how this routing scheme is achieved.

Initially, all Remote device routes are unknown. The Master/AP assumes that all undiscovered Remotes can potentially be on the SAF link. Once a Remote attempts to communicate upstream to the Master/AP, the Master/AP is aware of the Remote's path based on the exchange type, direct or SAF. The Master/AP stores this information in a database linked to the Remote's address. Future exchanges with the Remote initiated by the Master/AP will reference this database and the Master/AP chooses the most recent exchange type.

Upstream, the Remote can freely choose the best exchange type based on what is available at the time. The Master/AP continuously updates the routing database on each exchange to a Remote. If a Remote has not been heard from within a certain time frame, the route is reset to initial conditions so that the route may be “relearned.” This does not cause any additional delay and is implemented only as a safeguard. This allows for highly efficient and adaptable routing to each Remote device without the overhead of a routing protocol, and saves critical bandwidth.

## Diagnostic Settings

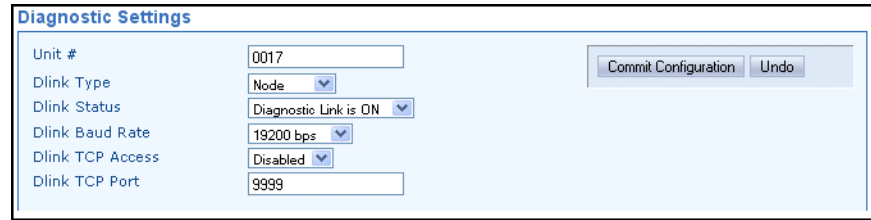

Diagnostic Settings	
Unit #	<input type="text" value="0017"/>
Dlink Type	<input type="button" value="Node"/>
Dlink Status	<input type="button" value="Diagnostic Link is ON"/>
Dlink Baud Rate	<input type="button" value="19200 bps"/>
Dlink TCP Access	<input type="button" value="Disabled"/>
Dlink TCP Port	<input type="text" value="9999"/>

- **Unit #**—This parameter identifies the radio in the wireless network with a specific ID during diagnostic sessions. This value is defaulted to the last 4-digits of the unit’s Serial Number. Should a network require a Unit # change, the value must be greater than 10000 in decimal (2710 in hexadecimal).
- **Dlink Type**—This setting identifies the radio as either a *Node*, *Root*, *Repeater*, *Peer*, or *Gate*. Each of these are operating modes of the transceiver with respect to diagnostic/management activities. (See “Performing Network-Wide Remote Diagnostics” on Page 93 for details.)
- **Dlink Status**—This item is used to enable or disable diagnostics functionality. Setting it to **ON** configures the radio to pass the diagnostic link protocol (DLINK) over the radio’s COM1 management port.
- **Dlink Baud Rate**—This setting determines the COM1 serial data diagnostics communication rate in bits-per-second (bps).
- **Dlink TCP Access**—This setting enables DLINK over Ethernet via TCP. This allows an external NMS to manage the radio without the need to dedicate a serial port for this function.
- **Dlink TCP Port**—This setting specifies the TCP port for DLINK communication. The address for Ethernet-based DLINK communication is given by the radio's IP address (from the **Overview** screen) and the port number specified here.

## Advanced Settings

Advanced Settings	
Soft-Carrier Dekey (ms)	<input type="text" value="0"/>
RX Time-Out Enable	<input type="button" value="OFF"/>
RX Time-Out Delay (min)	<input type="text" value="0"/>
TX Time-Out Status	<input type="button" value="ON"/>
TX Time-Out Delay (sec)	<input type="text" value="30"/>
Datakey	<input type="button" value="ON"/>
RTSkey	<input type="button" value="OFF"/>
Push-To-Talk Delay (ms)	<input type="text" value="0"/>
Clear-To-Send Delay (ms)	<input type="text" value="0"/>
Automatic Freq. Correction	<input type="button" value="OFF"/>
Switched Carrier (B modems)	<input type="button" value="OFF"/>
RX Signal Attenuation	<input type="button" value="OFF"/>
Force DCD to Asserted	<input type="button" value="OFF"/>
Modem Receive Tolerance	<input type="button" value="NORMAL"/>
Data Key Hold Time-out (chars)	<input type="text" value="2"/>

- **Soft-Carrier Dekey (ms)**—Specifies how long (in ms) to wait after the removal of the keying signal before actually dropping the transmitter's carrier. The default setting is 0, but it may be set to any value up to 255 ms. In most cases, no change is required from the default setting. A possible exception is when the transceiver is inter-working with certain early-generation MDS radio equipment.
- **RX Time-Out Enable**—Enables or disables the RX time-out function. RX time-out protects against a receiver which fails to receive data for a period exceeding the RX time-out delay setting (see below). When the time is exceeded, an alarm is issued. The alarm may be used to signal switchover to an alternate unit in redundant systems. The RX time-out is cleared when the radio receives a new Carrier Detect signal. The default selection is OFF (no RX time limit).
- **RX Time-Out Delay (min)**—Sets the time delay, after which an alarm is issued when no signals have been received. The default setting is 0 minutes.
- **TX Time-Out Status**—Enables or disables the TX Time-Out function. This protects against a transmitter which remains keyed for a period exceeding the TX Time-Out Delay setting (see below). When this time is exceeded, the transmitter is taken offline, preventing disruption of the wireless network. The TX time-out is cleared when the keying source goes away and the radio keys again. The default selection is ON (transmitter shuts down when time limit is reached).
- **TX Time-Out Delay (sec)**—Sets the time delay, after which a keyed transmitter is taken offline. The default time-out setting is 30 seconds.
- **Datakey**—Determines whether or not the radio is configured to key (transmit) upon receipt of payload data at its interface port. The default setting is ON.
- **RTS Key**—Determines whether or not the radio is configured to key (transmit) upon receipt of an RTS (ready to send) signal at its interface port. The default setting is OFF.

- **Push-To-Talk Delay (ms)**—Allows programming a brief time delay after a keying event, which must expire before the radio is allowed to transmit. The allowable range is 0 to 255 ms, with the default being **0**.
- **Clear-To-Send Delay (ms)**—Allows programming a brief time delay between when an RTS (ready-to-send) signal is received and when the CTS (clear-to-send) signal is returned. The allowable range is 0 to 255 ms, and the default is **0**.
- **Automatic Freq. Correction**—Automatic Frequency Correction (AFC), is used to counteract the slight RF frequency drift that may occur over time or through wide swings of ambient temperature.
- **Switched Carrier (B Modems)**—In some networks, the Master unit is not keyed continuously (Ckeyed), and transmits only when it has data to send to Remotes. This is known as Switched Carrier operation. The Switched Carrier setting is only for use on radio modems with “B” suffixes (for compatibility with MDS x710 radios). In such networks, the Remote radios should have the **Switched Carrier** setting turned **ON**. The default setting is **OFF** which assumes B-modem operation with a continuously keyed Master. Ckey Operation only applies to Master units operating in full-duplex mode only. Master units in B-modem networks will have **SWC** set to **ON** regardless of Ckey being on or off.
- **RX Signal Attenuation**—This setting is intended for use in strong signal environments (typically -70 dBm or stronger). When enabled the radio will tolerate very strong signals of -20 dBm or stronger. Note that RX Signal Attenuation will reduce sensitivity by a few dB, so it should be disabled for maximum sensitivity when working with extremely weak signals.
- **Force DCD to Asserted**—Some systems require a constant Data Carrier Detect (DCD) signal. This setting allows the radio to be configured to provide a DCD signal without the need for special cabling.
- **Data Key Hold Time-out (chars)**— For networks with the demand for a higher modem speed than the baud rate, this parameter can be adjusted from 1 to 10 characters. This parameter gives the overall network better performance by preventing frequent key-up and key-down sequences between characters. This only applies to networks with all-SDx radios. The default setting is 2 characters.

## Features

### Bridge Configuration

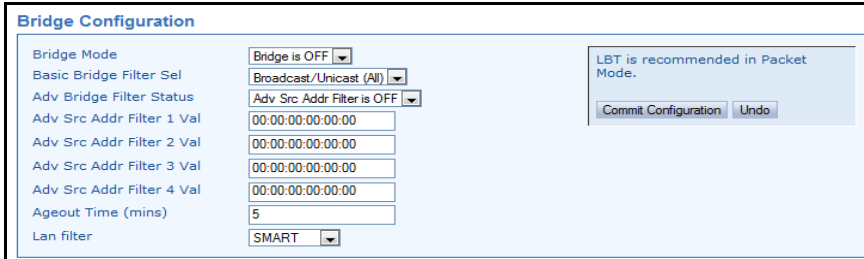

- **Bridge Mode**—Used to enable or disable Ethernet Bridging on the radio. Default setting is **OFF**.
- **Basic Bridge Filter Sel**—Sets the type of bridge filter to be used. Available selections are: **Broadcast/Unicast (All)**, **Unicast and ARP**, and **Unicast Only**.
- **Adv Bridge Filter Status**—When on, this filter bridges the Ethernet traffic received from a specific Ethernet-enabled device matching one of the Adv Src Addr Filter Values (see below).
- **Adv Src Addr Filter 1-4 Val**—Sets the Advanced SRC Address Filter Values. Four address fields are available. If the Adv Bridge Filter Status is on, and an incoming Ethernet frame src addr matches any of these values, the radio bridges the frame. Otherwise, it is dropped by the radio. The entry format must be **xx:xx:xx:xx:xx:xx**.
- **Ageout Time (mins)** — Defines the amount of time (in minutes) a radio holds a specific MAC entry in the Bridge route table. The parameter can be varied from 0 to 5 minutes. Default for this setting is 5 minutes.
- **Lan filter** — When set as **SMART**, this filter prevents any packets which were transmitted from one endpoint to another which are connected through a hub on a single transceiver. Default is **AUTO**.

---

**NOTE:** This feature should be disabled if there is a redundant bridge in the network.

---

### VLAN Configuration

A VLAN is essentially a limited broadcast domain, meaning that all members of a VLAN receive broadcast frames sent by members of the same VLAN but not frames sent by members of a different VLAN.

The radio supports port-based VLAN at the Ethernet interface and over the air, according to the IEEE 802.1Q standard. When VLAN Mode is enabled, the wireless port of both AP and Remote radios act as a Trunk port.

The Ethernet port of an AP radio is normally configured as a trunk port. This type of port expects incoming frames to have a VLAN ID and sends outgoing frames with a VLAN structure as well. The Ethernet port of a Remote radio can be configured as an Access port or as a Trunk port.

When the Wireless or Ethernet port (AP or Remote) is configured as an Access Port, the radio tags incoming traffic with a VLAN ID, and strips the tag before sending out traffic. This traffic is known as the Data VLAN. Additionally, a *second* VLAN is assigned for other traffic that is terminated at the radio, such as Web, Telnet, DLINK over TCP, TFTP reprogramming, etc. This traffic is known as the Management VLAN. Traffic directed to the terminal server or IP payload service should be sent via the Data VLAN.

When the Ethernet port of a Remote is configured as a VLAN trunk, the radio expects all incoming Ethernet frames to be tagged, and passes through all outgoing frames as received from the wireless link with the unchanged VLAN tag.

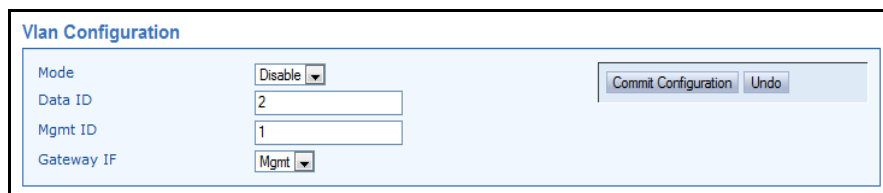

Vlan Configuration	
Mode	Disable
Data ID	2
Mgmt ID	1
Gateway IF	Mgmt

- **Mode**—Defines the Ethernet port as **Trunk**, **Access**, or **Disable** (an untagged port). The default setting is **Disable**. **The mode should be the last parameter changed when configuring the VLAN feature, since any Telnet or web connections will be lost after it is changed.** Also, configure the appropriate IP and IP2 settings before changing this parameter.
- **Data ID**—Defines the VLAN ID assigned to the AP's LAN traffic to be delivered to an Access Port, and the terminal server service, or the IP payload service. The ID is used for filtering and tagging purposes. Any valid ID from 1 to 4095 may be entered. The Default Data VLAN ID is **2**.
- **Mgmt ID**—Defines the VLAN ID assigned to the AP's LAN traffic that is to be delivered to the radio. Note that traffic for the terminal server and IP payload service is expected in the data VLAN. This ID is used for filtering and tagging purposes. Any valid ID from 1 to 4095 may be entered. The Default Mgmt VLAN ID is **1**.
- **Gateway IF**—Defines the VLAN that contains the default gateway in the radio. Available selections are **Mgmt** and **Data**. The default setting is **Mgmt**.

---

**NOTE:** The **VLAN Mode** parameter must be consistent at both the AP and Remote radios in order for data to flow correctly. Failure to do so may result in data not being transported correctly even when the radios are able to communicate over-the-air via an RF link.

---



## Listen Before Transmit (LBT) Settings

The transceiver provides a legacy collision avoidance scheme called *Listen Before Transmit* (LBT). It employs P-Persistent CSMA protocol, which senses channel usage and inhibits transmission if the channel is currently in use. CSMA is an abbreviation for Carrier Sense Multiple Access. This setting is superseded by Packet w/MAC and should only be used in legacy systems and special use cases. Packet w/MAC is the preferred method for collision avoidance.

---

**NOTE:** The Listen Before Transmit (LBT) feature requires radios to be configured for *Packet Mode* operation. Packet w/MAC operation provides an alternative method for media access.

---

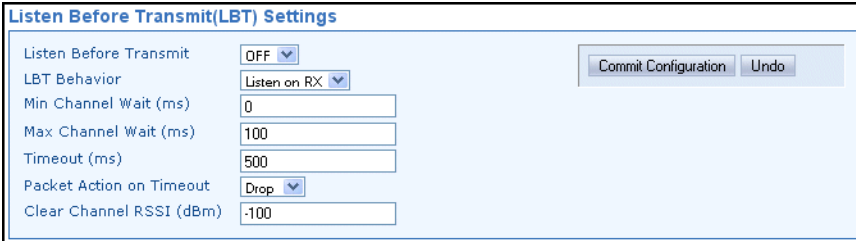

- **Listen Before Transmit**—Used to activate or deactivate LBT when the radio is running in Packet Radio Mode.
- **LBT Behavior**—LBT can be configured to behave in one of two ways; either *listen on the radio's transmit frequency (TX)* or *listen on the radio's receive frequency (RX)*. Typically, Remote radios are configured to **Listen on RX** (the default selection) to avoid collisions with the Master unit. In split frequency operation, **Listen on TX** may be preferred. Optimal choices depend on the data transmission characteristics of the connected system.
- **Min/Max Channel Wait (ms)**—These settings refer to the time period (in milliseconds) to wait after the channel is free before transmission is allowed.

*Minimum wait time:* Normally, the minimum channel wait time should not be changed from its default setting of **0 ms** unless performing advanced operations, such as staggering the responses from multiple Remotes.

*Maximum wait time:* Normally, this setting should not be changed from its default of **100 ms** unless performing advanced operations. Some examples of when this may be beneficial include:

- There is a need to stagger responses from several Remote radios.
- The transmission latency from the time the channel is free is too high, in which case a lower value can be entered.
- Collisions over the air are too high, in which case a higher value can be entered.

---

**NOTE:** The lower the value of the Maximum Wait Time, the higher the chances of collisions occurring over-the-air. Conversely, the higher the value of the Maximum Wait Time, the higher the transmission latency.

---

- **Timeout (ms)**—Provides a setting for the maximum wait time (in milliseconds) for the channel to become free. When this time is exceeded, the radio follows the action defined in the **Packet Action on Timeout** setting (either **Drop** or **Send**).
- **Packet Action on Timeout**—Determines what to do with a packet once the timeout period has expired and the channel is still not available. If set to **Drop**, the packet is discarded. If set to **Send**, transmission of the packet is attempted despite the channel being busy.
- **Clear Channel RSSI (dBm)**—LBT works by sensing the presence of a carrier signal on the radio's operating frequency. If a carrier is present, transmission is inhibited. The **Clear Channel RSSI** setting allows a threshold to be set which, when equaled or exceeded, declares the channel busy and therefore unavailable for transmitting.

### **IP Payload Configuration (1/2/3)**

This section describes how to setup and configure the Master radio for exchanging IP/Ethernet Payload data with Remote radios. It is an efficient feature that supports Ethernet connectivity with maximum over-the-air (OTA) efficiency for UDP and TCP data streams. Remote radios receiving the data can then forward this traffic to their serial ports or Ethernet port. This feature is particularly useful for adding Ethernet devices to a mixed system using MDS SDx and x710 Transceivers. This feature is different than Ethernet Bridging, which is described on Page 55 in the Bridge Configuration Section.

---

**NOTE:** To make use of this feature, the radio must be properly authorized for Ethernet data. If it is not, contact your sales representative for further information.

---

It is helpful to understand that IP data is terminated at the radio, yet the payload data is transmitted OTA. As such, the radio acts as a *terminal server* converting IP data into a serial “over-the-air port.” In other words, a transmitting radio receives an IP message, strips off the IP headers, and sends it over the air with VRC identification (VRC-1, VRC-2, or VRC-3). A receiving radio may then be set up, for example, to have COM2 or an IP port deliver *all* VRC-1 traffic.

The radio supports Ethernet operation on *three* IP payload ports. These settings are made on the **IP Payload Configuration Menu** (1, 2, or 3) as shown in the screen which follows later in this section. In the Master unit only, Multihost may need to be enabled if more than one IP Payload port is required. Multihost feature only pertains to Packet Radio Mode.

IP Payload is intended to be used in a poll-response system. An Ethernet device at the Master radio sends UDP/TCP poll messages to the Master's Ethernet port which is configured to listen for data. The poll is sent OTA and a RTU/PLC attached to one of the Remote radios (via serial or Ethernet) responds. The response is sent OTA back to the Master radio. The Master radio then sends the response back to the polling station via Ethernet.

When configuring this feature, you are notified of the success or failure of the operation. Additionally, Ethernet and OTA statistics can be monitored to inspect the success of the poll-response communication.

The following additional points apply to Ethernet payload operation:

- To make efficient use of limited bandwidth, this feature transports the *payload content* of Ethernet data to be sent over the air.
- This feature does *not* bridge Ethernet networks separated by radios. For more information, see Ethernet Bridging found on Page 55 in the Bridge Configuration section.
- A *broadcast* poll-response network is assumed, where addressing information is contained in the payload portion of the UDP/TCP messages.

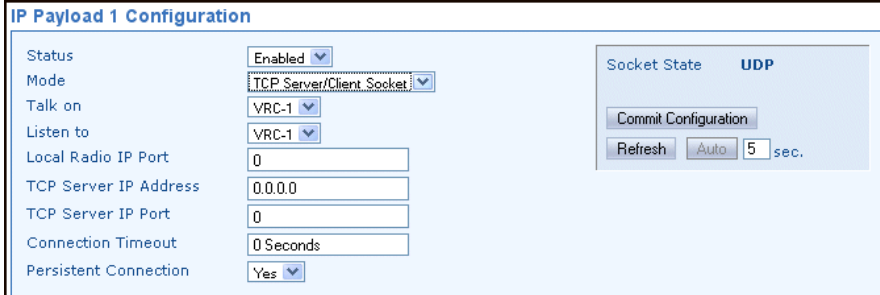

**NOTE:** Screen selections vary depending on the mode selected. Three such screens are provided for Payload 1, 2, and 3.

- **Status**—Enables or disables the IP Payload port.
- **Mode**—The operating mode for the IP port may be set to **UDP Socket**, **TCP Client Socket**, **TCP Server Socket**, or **TCP Server/Client Socket** to match the service in which it will operate.
- **Talk on/Listen to**—Any combination of the three Virtual Radio Channels may be entered in these fields. For more information on how VRC settings are used, refer to the *SD Serial/Telnet Management Supplement*, Part No. 05-6193A01.
- **Local Radio IP Port**—Used to specify a port number for the RJ-45 modular connector on the radio's front panel. As a general rule, port numbers below 2000 should be avoided, as some are reserved for special applications in data networks.

- **Destination IP Address**—Specifies the IP address associated with the device connected through the RJ-45 modular connector on the radio’s front panel (typically a PC). Any valid IP address may be entered.
- **Destination IP Port**—Used to specify a port number for the RJ-45 modular connector on the connected device (typically a PC). Port numbers below 2000 should be avoided, as some are reserved for special applications in data networks.
- **TCP Server IP Address**—IP address of the TCP server being used.
- **TCP Server IP Port**—Port number of the TCP server being used.
- **Connection Timeout**—Used to specify a time in seconds, after which the connection will be dropped following a period of inactivity.
- **Persistent Connection**—When set to **Yes**, the connection to the server is maintained continuously, even during periods of inactivity.
- **Committing Configuration**—Once you are satisfied with all of the settings on the screen, you make them active by clicking this button. The message **Changes committed** appears at the bottom of the screen to confirm the action.
- **Restoring Configuration**—In some cases, you may wish to revert to the previous configuration of the screen, prior to any changes being committed. This might be useful if one or more settings were inadvertently changed and you wish to return to a “known state.” To restore the prior settings, simply click **Restore Configuration**.

## Understanding the Use of Virtual Radio Channels (VRCs)

The use of **Virtual Radio Channels (VRCs)** may require additional explanation for new users of the feature. VRCs allow over-the-air data to be directed to specific interface ports (IP or Serial) on the radio. Conceptually, this can be pictured as creating “pipes” for delivery of data to the desired radio interfaces.

VRC works by associating data from a specific port (IP and Serial) with a VRC channel number (1, 2, or 3). Each port at the receiving end then filters incoming data based on the associated VRC number.

---

**NOTE:** The Virtual Radio Channel (VRC) feature is only supported in Packet and Packet w/MAC modes. It is not supported in Transparent or x710 mode.

---

To create the “pipes” that direct data to the desired ports, a route must be established using the IP Payload Configuration Menu (or the COM1/COM2 Settings Menu for serial data). The default setting is to listen to *all* channels.) The **Talk on** parameter is used to specify the VRC used for sending the data stream out, while the **Listen to** parameter specifies the VRC(s) for incoming data. Use of these parameters was described earlier in this section.

Any combination of the three VRC numbers may be entered in the selection fields. Figure 31 illustrates the relationship between the VRC settings and the routing of data between units.

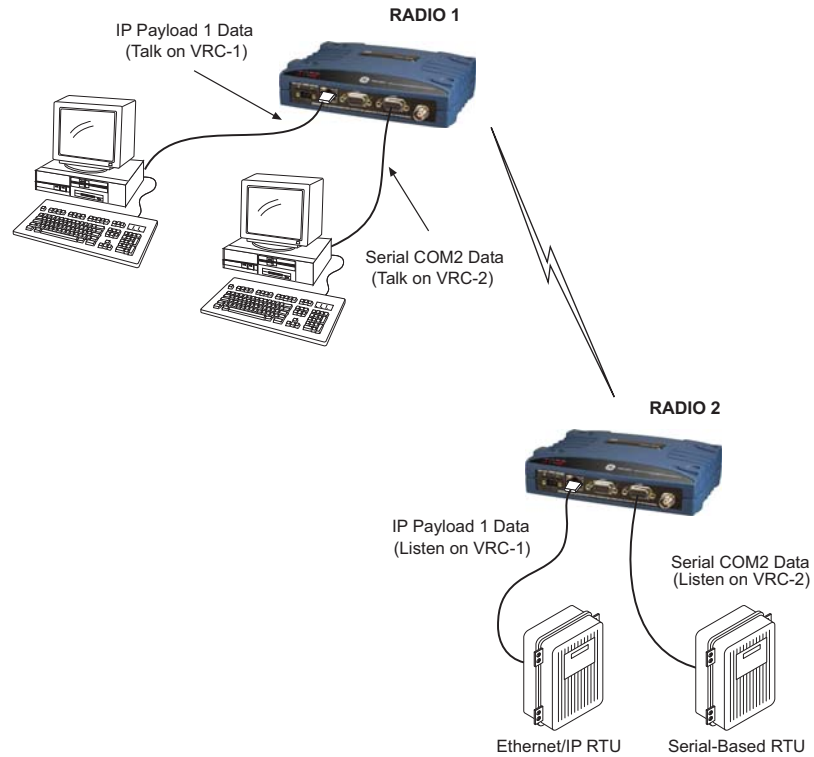

**Figure 31. Virtual Radio Channel (VRC) Concept**

### **Terminal Server COM1/2 Configuration**

The radio's Terminal Server feature allows IP addressing of the COM1 and COM2 serial interface ports. Data from these ports is sent over the air as encapsulated IP packets. At the receiving end, the data is decapsulated and delivered to the appropriate COM port(s). In contrast to the radio's IP Payload feature, having a terminal server at the Remotes means that Ethernet data can be delivered to *specific* devices connected to these radios. Terminal Server settings, examples, and additional benefits are described in the following paragraphs.

The image on the following page, shows the *Device Manager's Terminal Server Configuration* screen. Two such screens are provided in the *Device Manager*; one for COM1 and another for COM2. Here, the behavior of the terminal server is set and applied. The Terminal Server must be enabled and configured in *all* radios requiring IP encapsulation of serial data. Proper configuration of the serial ports is also required, using the *Communications Ports* section of the *Device Manager*.

**Term Svr COM1 Configuration**

Status	Disable ▾	
Mode	TCP Server Socket ▾	Socket State <b>Disabled</b>
Local Radio IP Port	1024	
Connection Timeout	5 Seconds	
Persistent Connection	No ▾	
Modbus TCP<->RTU Conversion	OFF ▾	

Commit Configuration

Refresh | Auto | 5 sec.

---

**NOTE:** Available selections vary depending on the mode selected.

---

- **Status**—Enables or disables the Terminal Server feature.
- **Mode**—Sets the operating mode for the IP port. It may be set to **UDP Socket**, **TCP Client Socket**, **TCP Server Socket**, or **TCP Server/Client Socket** to match the service in which it will operate.
- **Local Radio IP Port**—Used to specify a port number for the RJ-45 modular connector on the radio’s front panel. As a general rule, port numbers below 2000 should be avoided, as some are reserved for special applications in data networks.
- **Destination IP Address**—Specifies the IP address associated with the device connected through the RJ-45 modular connector on the radio’s front panel (typically a PC). Any valid IP address may be entered here.
- **Destination IP Port**—Used to specify a port number for the RJ-45 modular connector on the connected device (typically a PC). Port numbers below 2000 should be avoided, as some are reserved for special applications in data networks.
- **TCP Server IP Address**—IP address of the TCP server being used.
- **TCP Server IP Port**—Port number of the TCP server being used. Port numbers below 2000 should be avoided, as some are reserved for special applications in data networks.
- **Socket State**—Provides status on the configuration (*i.e.*, whether or not the terminal server port is active).
- **Modbus TCP<->RTU Conversion** — Used to convert Modbus TCP messages to Modbus RTU, and conversely, Modbus RTU to Modbus TCP. This feature eliminates the need for external equipment to handle the conversion.

The Terminal Server supports the following communication protocols:

- Point-to-Point: TCP or UDP
- Point-to-Multipoint<sup>1</sup>: UDP (One of the Destination IP Addresses is a multicast IP address)
- Multipoint-to-Multipoint<sup>1</sup>: UDP (Two or more of the Destination IP Addresses are a multicast IP address)

<sup>1</sup>Data from local multicast IP addresses is always delivered to the socket layer by the radio’s TCP/IP stack. Therefore, to receive data from local multicast IP addresses, simply set the Local Radio IP Port equal to the destination IP port of the multicast IP packet.

## Using the Terminal Server—Typical Example

The following describes a Terminal Server implementation in a radio network. Figure 32 below is referenced in this discussion.

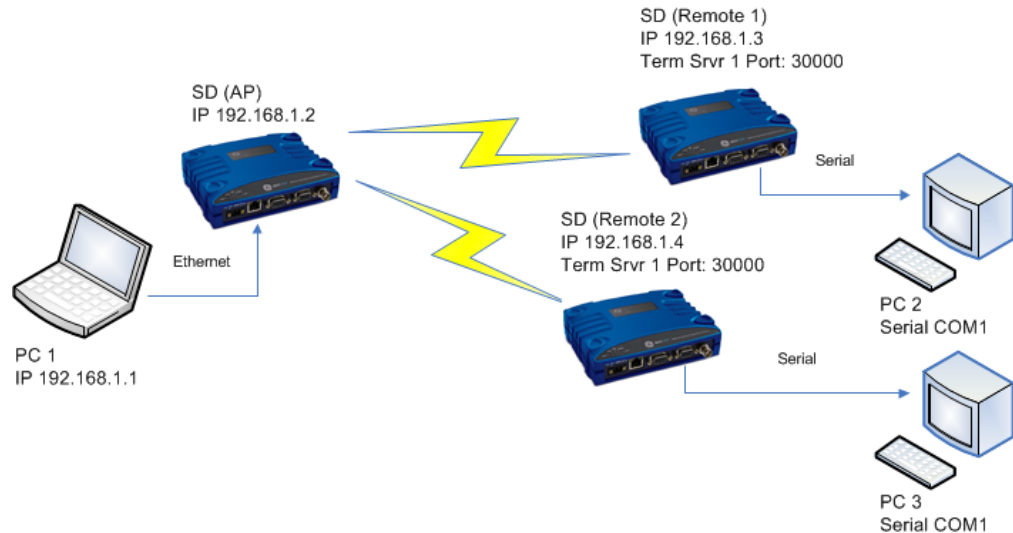

**Figure 32. Terminal Server Example**

### *IP/Radio Network Setup and Configuration*

The following conditions are assumed for this example:

- Radio (RF) link is good between AP and Remote 1, and AP and Remote 2.
- IP addresses are properly configured as shown in Figure 32.
- Packet w/MAC mode is enabled in all radios, and the **MAC Device Type** is set to **AP** in radio with the IP address equal to 192.168.1.2.
- Ethernet Bridge is enabled in all radios.

### **Serial Addressability**

This example shows that it is possible to communicate to specific serial devices (*e.g.*, PC 2 COM1, and PC 3 COM1) over the radio network. Note that TCP is used as the transport layer for communication here, which provides data reliability at the application level.

1. Configure Remote 1 and Remote 2 by navigating to the **Term Srvr 2 COM2 Configuration** screen and setting the parameters as listed below. (Note that an Ethernet connection to Remote 1 and Remote 2—not shown in Figure 32— will be required for this step unless Serial is used.)

**Status: Enabled**  
**Mode: TCP Server Socket**  
**Local Radio Port: 30000**  
**Connection Timeout: 0 Seconds**  
**Persistent Connection: Yes**  
**TCP<->RTU Conversion:**

2. Navigate to the **COM2 Port Settings** of Remote 1 and Remote 2 and configure them as listed below (note that VRCs are not used):

**Mode: RS232**  
**Baud Rate: 115200 bps**  
**Format: 8 char bits, no parity, 1 stop bit**  
**Buffer: Data Handling ON**  
**Device: DCE**  
**Talk on: VRC-1**  
**Listen to: ALL**

3. Click **Commit Configuration** after the changes are made.

To test the functionality of the Terminal Server, open a HyperTerminal session on PC1 and connect to the Remote 1 Terminal Server as shown in Figure 33.

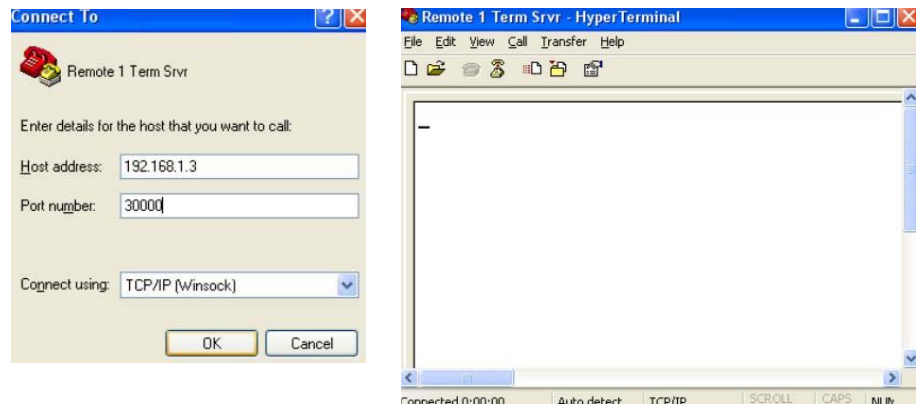

**Figure 33. Remote 1 Terminal Server Connection**

On PC2, open a HyperTerminal session and connect to Remote 1's COM2 port as shown in Figure 34.

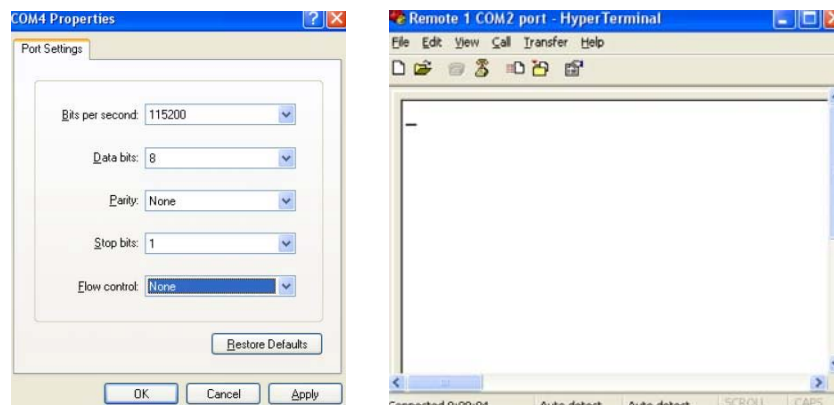

**Figure 34. Remote 1 COM2 Port Connection**

On PC1, open a HyperTerminal session and connect to Remote 2 Terminal Server as shown in Figure 35.



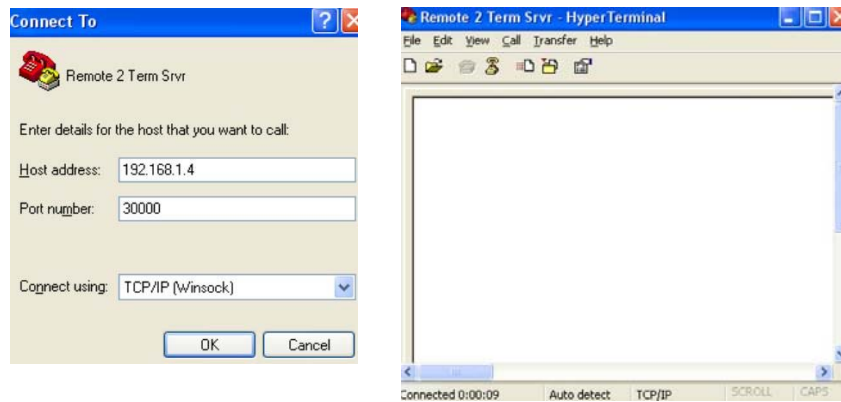

**Figure 35. Remote 2 Terminal Server Connection**

On PC3, open a HyperTerminal session and connect to Remote 2’s COM2 port as shown in Figure 36.

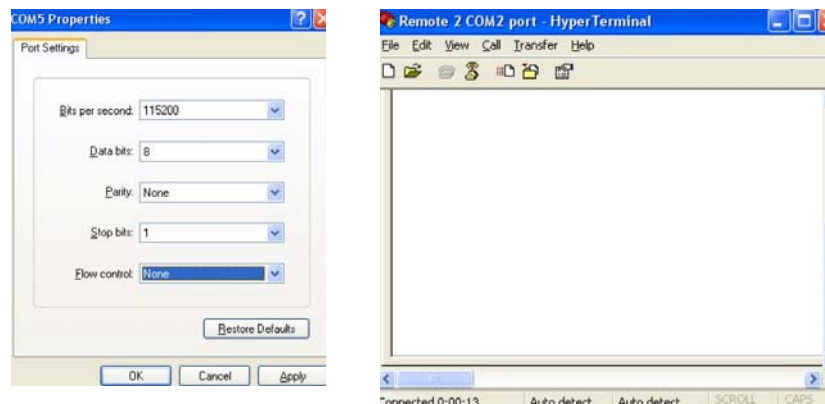

**Figure 36. Remote 2 COM2 Port Connection**

Type “hello” in the Remote 1 Terminal Server window. Note delivery of the message only to the Remote 1 COM2 Port window (see Figure 37). Type “hi” in the Remote 1 COM2 port window. Note delivery of message only to the Remote 1 Terminal Server window. This verifies proper delivery and routing of traffic.

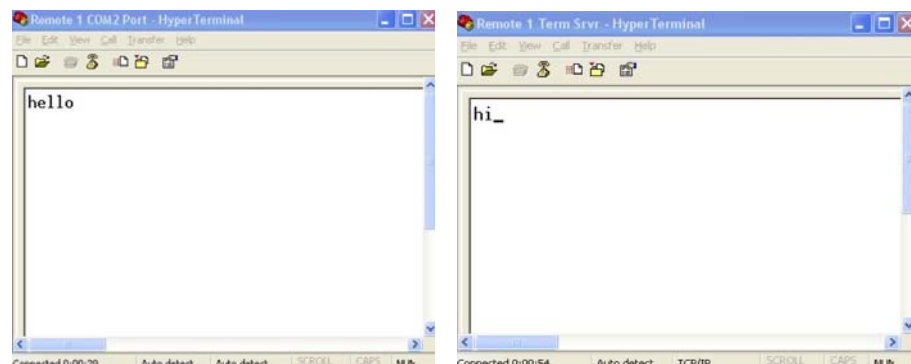

**Figure 37. Remote 1 Terminal Server/COM2 Port Communication**

Type “how are you” in the Remote 2 terminal server window (see Figure 38). Note delivery of the message only to the Remote 2 COM2 Port window. Type “good” in the Remote 2 COM2 Port window. Note delivery of message only to Remote 2 terminal server window.

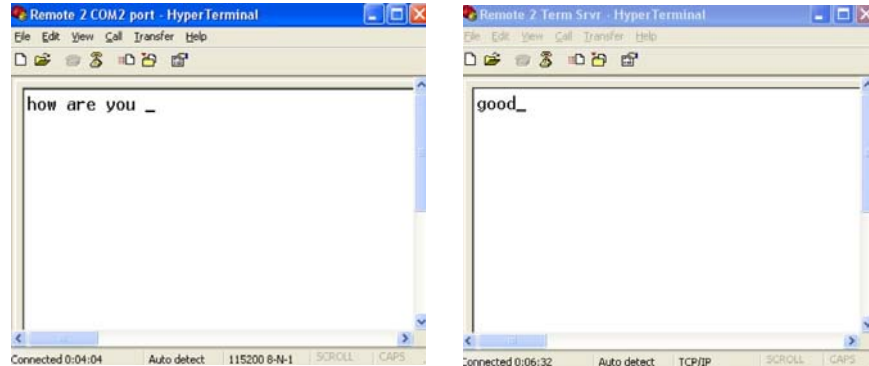

**Figure 38. Remote 2 Terminal Server/COM2 Port Communication**

***Multihost Settings  
 (Use only if operating  
 in Packet mode  
 without MAC)***

Multihost is a legacy feature that has been superseded by the Packet w/MAC feature. It should only be used in legacy systems or in special use cases.

The **Multihost Settings** screen is used only when Packet mode is selected. It provides an alternative way to run multiple host applications at the Master unit, which may be operating on different computers. Multihost operation is described in more detail in the *SD Serial/Telnet Management Supplement*, Part No. 05-6193A01.

Packet w/MAC operation replaces multihost operation, and is the recommended method for passing multiple data streams. See Device Settings starting on Page 46 for instructions on setting the Radio Mode to Packet w/MAC.

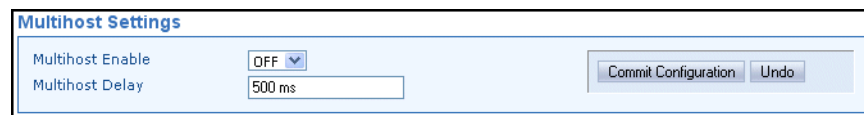

- **Multihost Enable**—Enables or disables multihost capability.
- **Multihost Delay**—Sets the desired delay time (in ms) for switching between hosts during multihost operation.

## Peer-to-Peer (Peer2Peer)

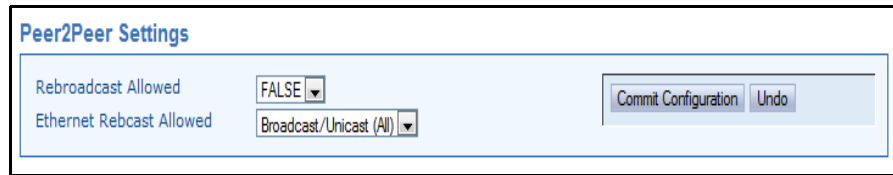

**Peer2Peer Settings**

Rebroadcast Allowed

Ethernet Rebcast Allowed

- **Rebroadcast Allowed (AP only)** — Determines if the AP will allow enabled Peers to communicate through the AP to other enabled Peers (serial data only).
- **Ethernet Rebcast Allowed (AP only)**—Determines if the AP will allow enabled Peers to communicate through the AP to other enabled Peers (Ethernet data only).

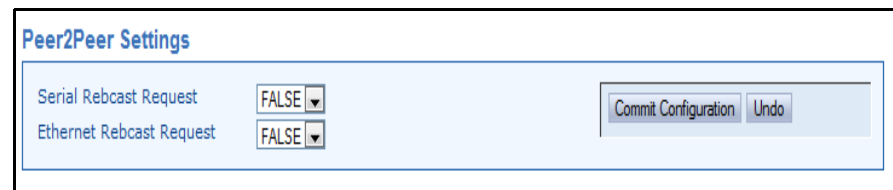

**Peer2Peer Settings**

Serial Rebcast Request

Ethernet Rebcast Request

- **Serial Rebcast Request (RM only)** — Determines if the Remote is allowed to communicate to other enabled Peers.
- **Ethernet Rebcast Request (RM only)**—Determines if the Remote is allowed to communicate to other enabled Peers.

## Communications Ports

### COM1 Port Settings



**COM1 Port Settings**

Startup Mode

Current Mode

Data Baud Rate

Data Format

Talk on

Listen to

Term Srvr Status

- **Startup Mode**—The default mode for COM1 is **Console** when the transceiver is first powered up, but the startup mode may also be set to **Data** if the port is to be used for passing payload data.
- **Current Mode**—The mode setting for the COM1 port may be changed on demand (**Console** or **Data**) using this selection.
- **Data Baud Rate**—The default data rate for COM1 is 115200 bps, but it may be set to any of the following speeds: 300, 1200, 2400, 4800, 9600, 19200, 38400, 57600, 115200.

- **Data Format**—The default data format for the transceiver is 8 character bits, no parity, and 1 stop bit (8N1). A number of settings are possible as listed below:

8 character bits, no parity, 1 stop bit (Default)  
 8 character bits, no parity, 2 stop bits  
 8 character bits, odd parity, 1 stop bit  
 8 character bits, odd parity, 2 stop bits  
 8 character bits, even parity, 1 stop bit  
 8 character bits, even parity, 2 stop bits  
 7 character bits, no parity, 1 stop bit  
 7 character bits, no parity, 2 stop bits  
 7 character bits, odd parity, 1 stop bit  
 7 character bits, odd parity, 2 stop bits  
 7 character bits, even parity, 1 stop bit  
 7 character bits, even parity, 2 stop bits

- **Talk on/Listen to**—Any combination of the three Virtual Radio Channels may be entered in these fields. Refer to the *SD Serial/Telnet Management Supplement*, Part No. 05-6193A01 for more information.
- **Term Srvr Status**—Indicates whether the radio’s Terminal Server is enabled or disabled.

### COM2 Port Settings

COM2 is the standard port used for connection of serial payload data. The **COM2 Port Settings** screen contains a number of settings that may be configured to suit the needs of your system.

The screenshot shows the 'COM2 Port Settings' window with the following configuration:

- Mode: RS232
- Baud Rate: 9600 bps
- Format: 8 char bits, no parity, 1 stop bit
- Buffer: Data Handling ON
- Device: CTS KEY
- Talk on: VRC-2
- Listen to: VRC-2
- Term Srvr Status: Disable

- **Mode**—The COM2 port can operate in either RS-232 or RS-485 mode. The default is **RS-232**.
- **Baud Rate**—The default data rate for COM2 is **9600 bps**, but it may be set to any of the following speeds: 300, 1200, 2400, 4800, 9600, 19200, 38400, 57600, 115200.
- **Data Format**—The default data format for the transceiver is 8 character bits, no parity, and 1 stop bit (8N1). A number of settings are possible as listed below:

8 character bits, no parity, 1 stop bit (Default)  
 8 character bits, no parity, 2 stop bits  
 8 character bits, odd parity, 1 stop bit  
 8 character bits, odd parity, 2 stop bits  
 8 character bits, even parity, 1 stop bit  
 8 character bits, even parity, 2 stop bits  
 7 character bits, no parity, 1 stop bit  
 7 character bits, no parity, 2 stop bits  
 7 character bits, odd parity, 1 stop bit  
 7 character bits, odd parity, 2 stop bits  
 7 character bits, even parity, 1 stop bit  
 7 character bits, even parity, 2 stop bits

- **Buffer**—The transceiver’s buffer provides a way of handling data “over-runs,” where more data is passing through the COM2 port than can be immediately handled by the unit. When the buffer is on, any such data is stored up and processed in the appropriate order. Available selections are **Data Handling ON** or **Data Handling OFF**.
- **Device**—This setting controls the device behavior of x710 legacy radios. It does not apply to packet or Ethernet radios, and may be disregarded for these later models.
- **Talk on/Listen to**—Any combination of the three Virtual Radio Channels may be entered in these fields. For more information on how these settings are used, refer to the *SD Serial/Telnet Management Supplement*, Part No. 05-6193A01 more information.
- **Term Svr Status**—Indicates whether the radio’s terminal server is enabled or disabled.

---

**NOTE:** The radio can operate in RS-422 mode when RS-485 is selected.

---

## IP Configuration

The **IP Configuration** screens contain various settings for the IP data stream. Each item is listed below along with an explanation of the parameter. Note that the top of the screen displays the *current settings* that have been applied to the radio in a read-only fashion.

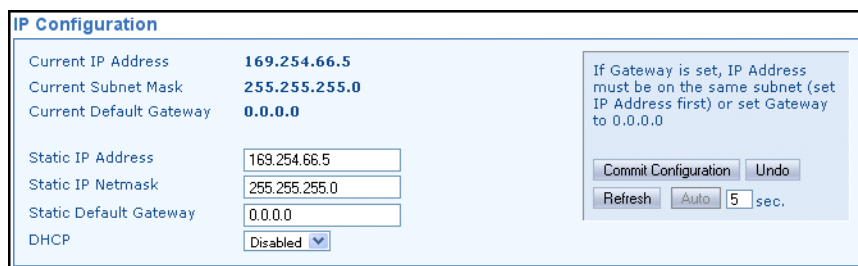

The screenshot shows the 'IP Configuration' screen with the following fields and values:

Field	Value
Current IP Address	169.254.66.5
Current Subnet Mask	255.255.255.0
Current Default Gateway	0.0.0.0
Static IP Address	169.254.66.5
Static IP Netmask	255.255.255.0
Static Default Gateway	0.0.0.0
DHCP	Disabled

Additional controls on the right side include a warning message: "If Gateway is set, IP Address must be on the same subnet (set IP Address first) or set Gateway to 0.0.0.0". Below this are buttons for "Commit Configuration", "Undo", "Refresh", "Auto", and a timer set to "5 sec".

- **Current IP Address**—Read-only indication of the current IP address programmed.
- **Current Subnet Mask**—Read-only indication of the subnet mask programmed.
- **Current Default Gateway**—Read-only indication of the current default gateway programmed.
- **Static IP Address**—The radio requires a local IP address to support remote management and serial device (terminal server) services. An IPv4 IP address should be entered in this field, unless DHCP is enabled, in which case it is not required.

- **Static IP Netmask**—This refers to the radio’s IPv4 local subnet mask. This parameter is used when the radio attempts to send a locally-initiated message, either from the terminal server, or a management process. You do not need to define it if DHCP is enabled.
- **Static Default Gateway**—This is the IPv4 address of the default gateway device, typically a router connected to the radio.
- **DHCP**—Dynamic Host Configuration Protocol (DHCP) handles the assignment of IP parameters (Address, Netmask, Gateway) to all units in a network, and allows for introducing new devices on the network with minimal manual intervention. The assigned parameters are valid for a specific “lease” time, at which point they can be reassigned or renewed.

## Security

The transceiver offers a number of safeguards against unauthorized management access and protection of payload data. All of these features are accessed via the security configuration screens.

### Device Security

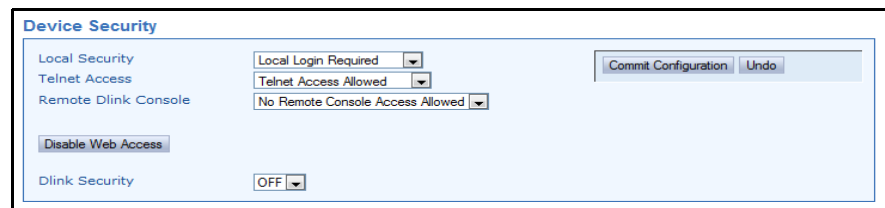

- **Local Security**—This parameter is used to specify whether or not a local log-in is required when using the transceiver’s menu system. The default setting is **Local Login Required**, and is appropriate for most circumstances. Setting this parameter to **No Local Login Required** might be useful in cases where only a small number of people with administrative duties have physical access to the radio, and need to access the menu frequently. In this mode, the menu operation behaves identically to the Administrator level login.
- **Telnet Access**—Telnet access is a powerful feature that allows management of the radio via an Ethernet connection. This may be done locally, using a cable connected to the management PC, or at any distance using an IP/Ethernet network connection. Telnet access is also possible over the air if the Ethernet Bridging feature is enabled. Any user with the IP address of the radio can log in to the unit with this method.
- **Remote Dlink Console** — Contact GEMDS for more information.
- **Dlink Security** — Applies security restrictions to network-wide diagnostic data. The default setting is **OFF**. If **Dlink Security** is enabled, users performing network-wide diagnostics must perform a special login sequence via DLINK before being able to change the configuration of the radio via DLINK.

- **Disable Web Access**—Web access to the unit's *Device Manager* is normally enabled. Click this item to disable web access. A warning message appears to confirm disabling of web navigation.

---

**NOTE:** If web access has been disabled accidentally via the web *Device Manager*, the user must re-enabled it via the console or Telnet interface.

---

## Wireless Security

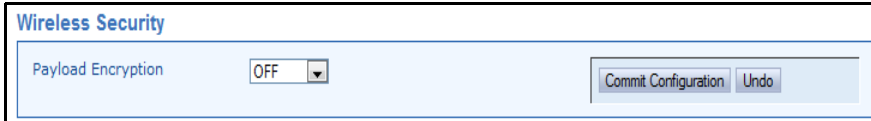

- **Payload Encryption**—When on, applies encryption to payload data stream. The default selection is **OFF**.

## Login Password

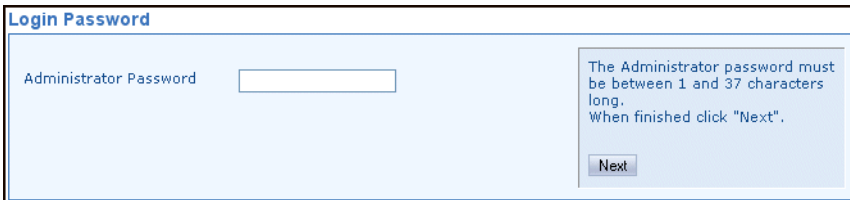

- **Administrator Password**—When the transceiver is shipped from the factory, the password is normally set to the default entry of **admin**. It is recommended that it be changed at the time of installation to one that is known only to the Administrator or authorized user of the system. The password should be changed periodically to maintain the best security.

Passwords are case sensitive and may use up to 13 alpha-numeric characters. Do not use punctuation mark characters. You will be required to enter the current password to set a new one. Follow the prompts, and refresh your web browser (typically **View>>Refresh** or **View>>Reload** at the top menu bar) to apply the change to all pages.

**TIP:** For enhanced security, consider using misspelled words, a combination of letters and numbers, and a combination of upper and lower case letters. Also, the more characters used (up to 13), the more secure the password will be. These strategies help protect against sophisticated hackers who may use a database of common words (for example, dictionary attacks) to determine a password.



**NOTE:** If the radio login password is lost or forgotten, contact GE MDS for assistance. Proof of authorized user is required for a new password, and the radio will revert to its default settings.

It is recommended that users periodically export their configuration file so that it can be loaded back into the radio if their old one requires replacement.

## Encryption Phrase

A screenshot of a web interface titled "Encryption Phrase". On the left, there is a label "Encryption Phrase" followed by a text input field. On the right, there is a text box containing the instructions: "Enter the Encryption Phrase. The Encryption Phrase must be between 8 and 38 characters. When finished click 'Next'." Below the text box is a "Next" button.

- **Encryption Phrase**—If encryption has been enabled, a valid “phrase” must also be set. Both the sending and receiving station must have the same phrase for communication to occur. The phrase must have at least 8 characters (maximum of 38), and any printable character may be used.

## Dlink Encryption Phrase

A screenshot of a web interface titled "Dlink Encryption Phrase". On the left, there is a label "Dlink Encryption Phrase" followed by a text input field. On the right, there is a text box containing the instructions: "Enter the Dlink Encryption Phrase. The Dlink Encryption Phrase must be between 8 and 38 characters. When finished click 'Next'." Below the text box is a "Next" button.

- **Dlink Encryption Phrase**—If AES encryption has been enabled while in Transparent mode, a valid “phrase” must be set for the use Dlink Encryption. Both the sending and receiving station must have the same phrase for communication to occur. The phrase must have at least 8 characters (maximum of 38), and any printable character may be used. Transparent w/AES Encryption requires an all SD radio network.



## 6.4 Maintenance & Status Screen

The **Maintenance & Status** screen (Figure 39) provides access to several tools used in testing the radio and performing routine management tasks. Individual screens may be selected beneath **Maintenance & Status** at the left side of the screen.

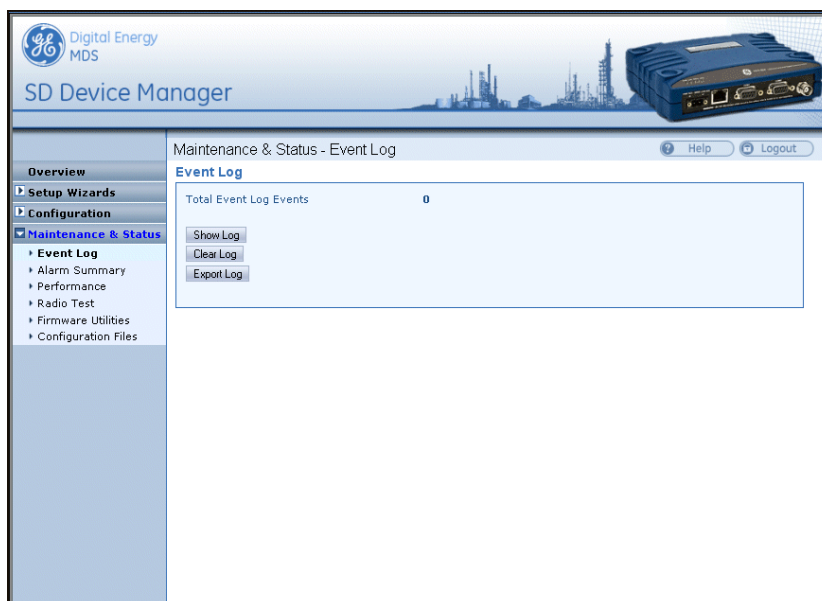

**Figure 39. Maintenance & Status Screen**

### Event Log

The Event Log is used to display all events stored by the transceiver, even if the radio has been power-cycled. It also shows a running total of the alarms stored.

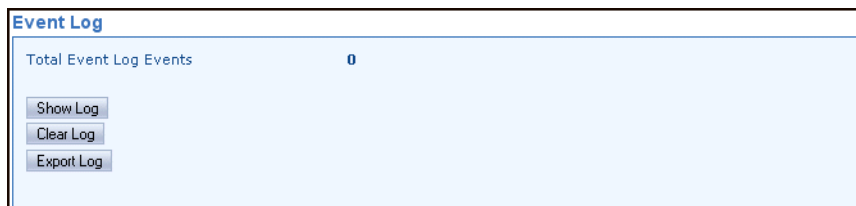

- **Total Event Log Events**—Displays the number of events that have been logged by the transceiver. To view the Event Log, click **Show Log**. The listed events can be cleared by clicking **Clear Log**. (You will be challenged by a caution message to verify that you intend to clear the event log.)
- **Show Log**—Displays a detailed listing of each event.
- **Clear Log**—Erases the stored listing of events.
- **Export Log**—Used to save the log data as a text file in the desired location on the PC.

## Alarm Summary

### Alarms

This screen shows the current major and minor alarms, if any, since power-up of the transceiver.

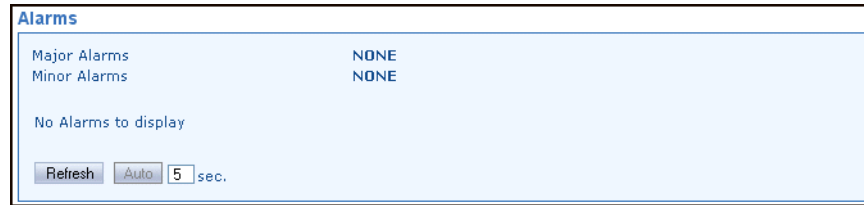

**Alarms**  
 Major Alarms NONE  
 Minor Alarms NONE  
 No Alarms to display  
 Refresh Auto 5 sec.

*This menu is read only.*

### Status Conditions and Events

This screen shows status conditions reported since power-up of the transceiver. This includes normal, informational events such as booting up the system and re-initializing.

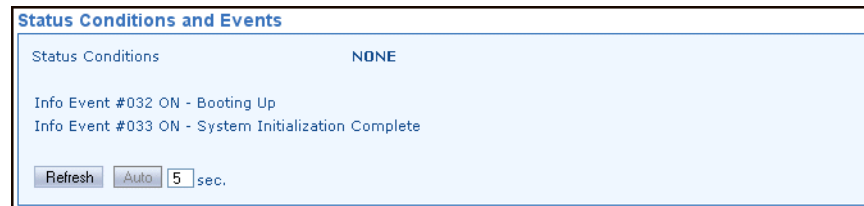

**Status Conditions and Events**  
 Status Conditions NONE  
 Info Event #032 ON - Booting Up  
 Info Event #033 ON - System Initialization Complete  
 Refresh Auto 5 sec.

*This menu is read only.*

### Alarm Signal Configuration

This screen contains settings to determine what events are detected, and what will be done with them. At the bottom section of the screen are selections for displaying specific alarms, conditions, and informational events that will be reported. Select events to be reported by clicking the box to the left of the item. The sample image below shows the first six events in the bottom portion of the screen. Additional listings are visible by scrolling down.

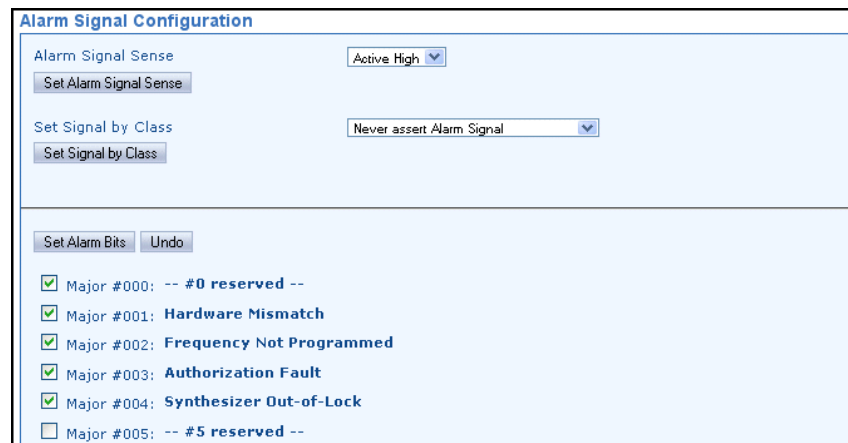

**Alarm Signal Configuration**  
 Alarm Signal Sense Active High  
 Set Alarm Signal Sense  
 Set Signal by Class Never assert Alarm Signal  
 Set Signal by Class  
 Set Alarm Bits Undo  
 Major #000: -- #0 reserved --  
 Major #001: **Hardware Mismatch**  
 Major #002: **Frequency Not Programmed**  
 Major #003: **Authorization Fault**  
 Major #004: **Synthesizer Out-of-Lock**  
 Major #005: -- #5 reserved --

- **Alarm Signal Sense**—This parameter may be set to either **Active High** or **Active Low**. An active high means that Pin 6 on the COM2 port will output a *high* DC signal when an alarm exists. (This is the default behavior.) An active low means that Pin 6 on the COM2 port will output a *low* DC signal when an alarm exists. Select the desired behavior in the drop-down box and click **Set Alarm Signal Sense** to apply the setting.
- **Set Signal by Class**—Here, you can specify what classes of alarms result in a signal being produced by the alarm output line. The choices are:

Never assert Alarm Signal  
 Assert Signal on Major Alarm  
 Assert Signal on Major or Minor Alarm  
 Assert Signal on Any Alarm or Status

- **Set Alarm Bits**—This button is used to set the selections made in the check box list below it. First, you must select which specific alarms will result in a signal being produced by the alarm output line. To set an alarm/message for reporting by the output line, you click the check box next to an item of interest. To clear a check box, simply click it again. When you are finished with the selections, click the **Set Alarm Bits** button.
- **Undo**—This button is used to return the screen to its original selections. It clears any selections made prior to clicking the **Set Alarm Bits** button.

## Performance

### Radio Performance

This screen contains several measurement parameters that can be used to check the operating conditions of the radio.

#### Radio Performance

Measured RF Power	30 dBm
Signal to Noise	25 dB
RSSI	-79 dBm
DC Voltage	13.9 Volts
Temperature	+36 C
<input type="button" value="Refresh"/> <input type="button" value="Auto"/> <input type="text" value="5"/> sec.	

- **Measured RF Power**—Read-only indication of the measured RF output power (in dBm).
- **Signal to Noise**—Read-only indication of the signal-to-noise ratio of received signal.
- **RSSI**—Read-only indication of the received signal strength (in dBm).
- **DC Voltage**—Read-only indication of the DC supply voltage applied to the transceiver.
- **Temperature**—Read-only indication of the chassis temperature (degrees C).

## I/O Statistics

This screen allows viewing transmitted and received bytes on any of the transceiver interface modules.

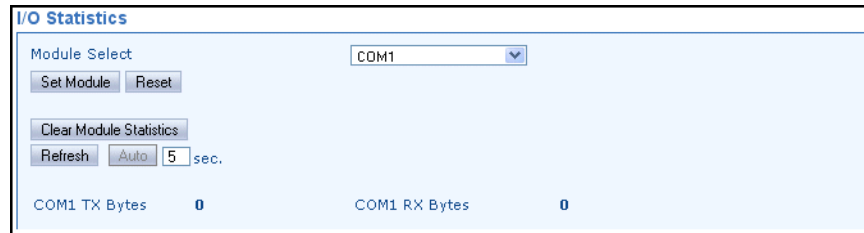

- Module Select**—The drop-down box to the right of this area allows selection of any of the transceiver interface modules: **All**, **Media Access Controller**, **Port(s)**, **COM1**, **COM2**, **IP Payload Port 1**, **2**, **3**, **Remote Reprogram**. Once a module is selected, click **Set Module** to view a summary of TX and RX bytes, along with the number of packets missed, retries, and number of blocks (as applicable, depending on the interface selected). The display continually refreshes to show the latest information, and may be cleared at any time by selecting **Clear Module Statistics**.
- Reset**—Clicking this button restores the previous **Set Module** selection. If you've scrolled to a new module selection in the pull-down box, and wish to return to the previous one, simply click this button to restore it.

## Ethernet Statistics

This screen presents a detailed summary of packets received and transmitted, dropped packets, errors, overruns of the buffer, RX data rate (bps), and RX/TX data for Unicast, Multicast, and Broadcast transmissions.

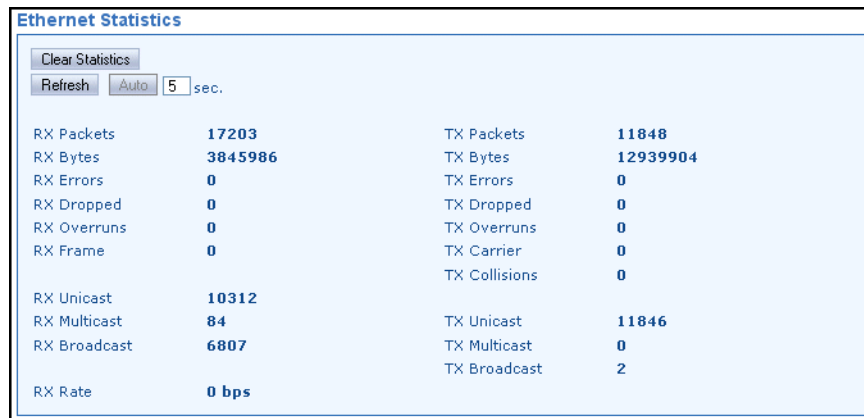

Ethernet Statistics			
Clear Statistics			
Refresh <input type="checkbox"/> Auto 5 sec.			
RX Packets	17203	TX Packets	11848
RX Bytes	3845986	TX Bytes	12939904
RX Errors	0	TX Errors	0
RX Dropped	0	TX Dropped	0
RX Overruns	0	TX Overruns	0
RX Frame	0	TX Carrier	0
		TX Collisions	0
RX Unicast	10312	TX Unicast	11846
RX Multicast	84	TX Multicast	0
RX Broadcast	6807	TX Broadcast	2
RX Rate	0 bps		

- Clear Statistics**—Clicking this button resets the displayed statistic counts.

## MAC Routes

The **MAC Routes** function pertains to Packet w/MAC operation and it is used as a networking tool. It works on both APs and Remotes, but is generally most meaningful from an AP perspective. The **MAC Routes** screen shows all currently communicating radios in a network running in Packet w/MAC mode.

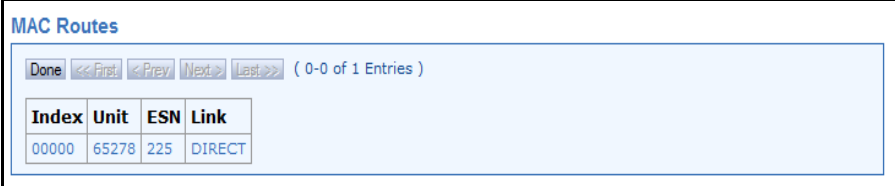

The screenshot shows the 'MAC Routes' interface. At the top, there are navigation buttons: 'Done', '<< First', '< Prev', 'Next >', and 'Last >>'. To the right of these buttons, it says '( 0-0 of 1 Entries )'. Below the navigation is a table with the following content:

Index	Unit	ESN	Link
00000	65278	225	DIRECT

Screen content varies with configuration. The following items are displayed on a fully populated screen for each radio, and appear in the blank area of the **MAC Routes** screen:

- **Index**—Numerical identification.
- **Unit**—Unit address of the radio.
- **ESN**—Exchange Sequence Number, an incrementing 8-bit sequence number used to uniquely identify packets coming from that radio. It is used for redundant packet filtering in case of re-transmissions.
- **Link**—Current link the radio is connected via, either **DIRECT** or through Store and Forward (**SAF**).
- **Clear Routes**—Forces the radio to re-learn all actively communicating radios in the network.
- **Export Routes** — Send MAC Route Entries to a local host.

Note that because the radio network is point-to-multipoint (from a Remote radio's perspective), the **MAC Route** function only contains information about the Access Point.

## Radio Test

The Radio Test functions are a collection of tools useful for testing the RF performance of the transceiver. It provides a way to key (activate) the transmitter, measure power output, run a spectrum test, and enable the built-in RTU simulator.

## RTU Simulator

The unit's built-in RTU simulator generates random data similar to what would be supplied by an external RTU connected to the radio. It is useful for system testing within the radio network by providing realistic data to pass over the radio channel.

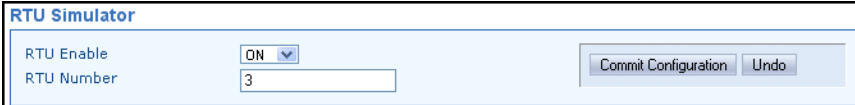

The screenshot shows the 'RTU Simulator' interface. It has two input fields: 'RTU Enable' with a dropdown menu set to 'ON', and 'RTU Number' with a text box containing the value '3'. To the right of these fields are two buttons: 'Commit Configuration' and 'Undo'.

- **RTU Enable**—Select **ON** or **OFF** from the drop-down box.
- **RTU Number**—Enter the desired RTU number in this box.

When you are done with these settings, press **Commit Configuration** to apply the changes.

### Link Test

The primary use of the Link Test is to verify that a specific radio's settings are consistent with the initiator including: Assigned frequency, unit number setting, encryption (if enabled), etc. Also collected at the same time is an indication of link quality. All radios are always ready to respond to a Link Test message. Only the initiating radio requires configuration when using the **Link Test** screen, and it is only available when operating in packet mode or Packet w/MAC mode.

A summary of data statistics is displayed on the right side of the screen, including transmit/receive packet counts, total bits, and total number of bit errors.

**NOTE:** No other data traffic should be active when performing a Link-Test.

- **Destination Unit Address**—Enter the Unit Address of the other radio being tested.
- **Linktest Count**—Enter the number of times for the message to be sent across the radio link.
- **Response Timeouts (msec)**—Enter the time (in milliseconds) that will result in a timeout if no response is received within that period.
- **Start Test**—Set this box to **ON** to start the Link Test, or **OFF** to stop the test.

When you are done with the settings above, press **Commit Configuration** to apply the changes.

### Ping Test

A connectivity test to a specific destination address may be performed using the radio's **Ping Test** screen which follows.

- **Destination Address**—Enter the IP Address of the radio to ping tested.
- **Count**—Enter the number of pings to send across the radio link.
- **Bytes**—Enter the number of bytes in each ping.
- **Interval**—Use this box to specify how long (in seconds) between ping transmissions after a response is received.
- **Timeout**—Use this box to specify how long (in seconds) to wait for a ping response before a timeout occurs.

### RF Keying Test

The **RF Keying Test** screen provides a way to place the transmitter on the air to check the measured RF power output, measure reflected power from an antenna system, or to provide a signal at a receiving station so that RSSI can be checked.

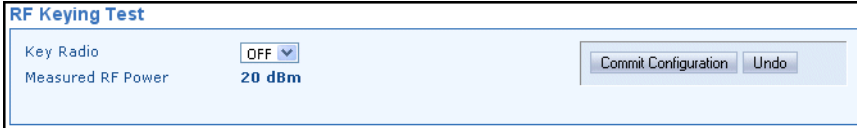

- **Key Radio**—Set to **ON** to enable the RF keying test; **OFF** to disable it. The **Commit Configuration** button must be clicked to apply the setting.
- **Measured RF Power**—Provides an indication (in dBm) of the measured power output of the transmitter.

### Spectrum Graph

A unique feature of the transceiver is the ability to view the RF spectrum above and below the operating frequency using its built-in Spectrum Graph. Often, this can assist in diagnosing the cause of interference, or to view other signals near your operating frequency.

To use the Spectrum Graph, you must first specify a *center frequency* and a *span frequency*. The *center frequency* is the frequency that you wish the spectrum display to be centered on. The *span frequency* defines the width of the overall spectrum to be examined.

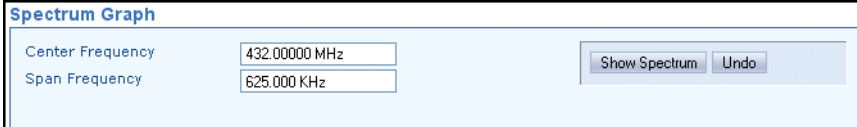

- **Center Frequency**—The frequency (in MHz) that the graph will be centered on.
- **Span Frequency**—Width (in kHz) of the spectrum to be examined.

A sample spectrum graph from the transceiver is shown below.

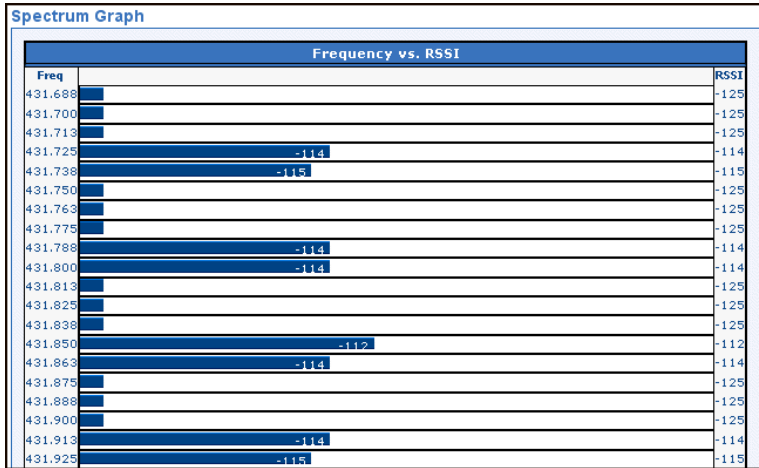

**Example Spectrum Graph**

### Alarm Test

The **Alarm Test** screen provides a way to force an alarm for testing alarm reporting and radio response. When set to **ON**, clicking the **Commit Configuration** button sets an alarm, and the radio's PWR LED begins to flash. An "Alarm Test" entry is also made in the Event Log, and the external alarm output status is changed.

In redundant configurations such as SDxP/SDxDP/SDxDT packaged models, the Alarm Test can be used to force a switchover between redundant radios. The alarm test is a timed facility. When applied, it will assert for 30 seconds, and then deactivate. If active, it can be manually deactivated prior to timeout by setting the parameter to **OFF**, and clicking the **Commit Configuration** button again.

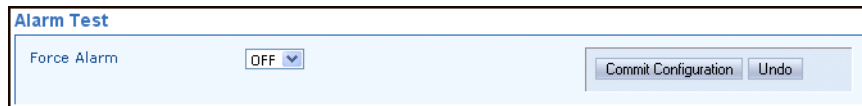



## Firmware Utilities

### Version Information

This screen shows Bootloader version information and indicates which firmware image (1 or 2) is currently active, as well as the firmware version of each image. The information on this screen is read-only.

Version Information	
Bootloader Software ID	6221A01
Bootloader Version	2.0.5
<b>Image 1 (active)</b>	
Package Version	4.1.2
App Software ID	6222A01
App Version	4.1.2
<b>Image 2</b>	
Package Version	4.1.2
App Software ID	6222A01
App Version	4.1.2
<input type="button" value="Refresh"/> <input type="button" value="Auto"/> <input type="text" value="5"/> sec.	

**This section is read only.**

---

**NOTE:** The latest firmware version for this product can be obtained at [www.gemds.com](http://www.gemds.com).

---

### Web Reprogramming

Web Reprogramming
<p>Please select the *.mpk file to reprogram into this radio, then click "Program" to start the file upload process.</p> <p><input type="text"/> <input type="button" value="Browse..."/></p> <p><input type="button" value="Program"/></p> <p><b>Please Note:</b> File upload and processing will take a few minutes to complete. Please be patient and do not click away from this page.</p>

Browse to the \*.mpk file to reprogram into this radio, then click **Program** to start the file upload process. Do not click away from this page until the upload has finished processing.

## TFTP Reprogramming

The **TFTP Reprogramming** screen contains settable parameters for TFTP file transfers and selections for retrieving files, such as radio firmware or configuration files.

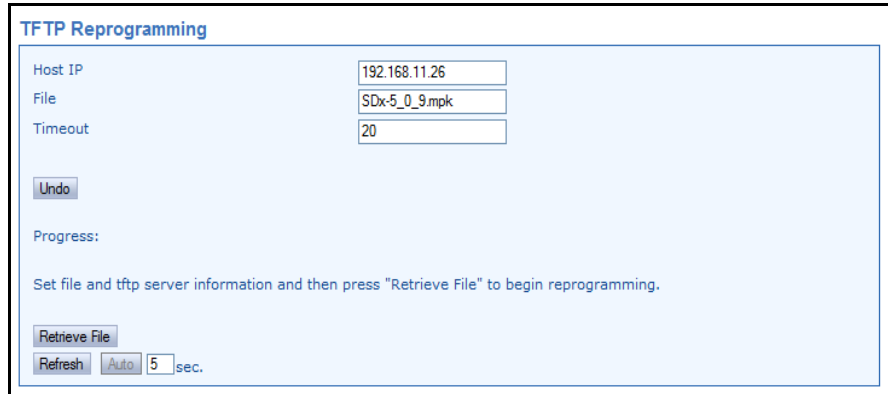

- **Host IP**—Use this field to enter a valid IP address for the host computer (where file to be transferred resides).
- **File**—This field is used to enter the exact name of the file to be imported or exported.
- **Timeout**—Determines the amount of time (in seconds) that the radio should wait for a TFTP server to respond. The default setting is **20** seconds and will not normally require any change. If a change is needed, enter a new timeout value in this field.

When all of the above fields have been set and you are ready to load a new file, click the **Retrieve File** button to begin reprogramming.

## Remote Reprogramming

The transceiver has facilities for reprogramming key settings of other radios in the network. These functions are contained on the **Remote Reprogramming** screen shown below. Additional information on remote reprogramming is given in “Over-the-Air Firmware Upgrades” on Page 94.

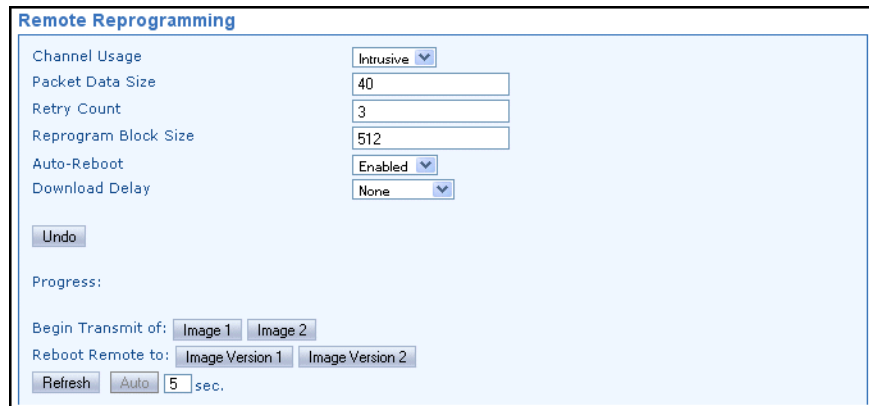

- **Channel Usage**—Set to either intrusive or passive as desired.
- **Packet Data Size**—Used to specify the size of the reprogramming data packets. Default size is 40.
- **Retry Count**—Used to specify the number of times a transmission is repeated when a packet is not received correctly. Default setting is 3.
- **Reprogram Block Size**—Sets the overall block size (in bytes) of each data packet. Default setting is 512.
- **Auto-Reboot**—When enabled, causes the transceiver to automatically reboot after a firmware image upgrade. If disabled, the newly loaded image will not become valid until the transceiver is rebooted manually.
- **Download Delay**—This field can be used to introduce a time delay when reprogramming begins. Typically, it is set to **Extended Delay-1**, but may be increased incrementally by selecting one of the extended delay times from the drop-down box (**Extended Delay-1, 2, 3, None**)

### Verify Image

This screen is used to verify the integrity of an image stored in flash memory. You may wish to verify an image after reprogramming or as part of a troubleshooting sequence.

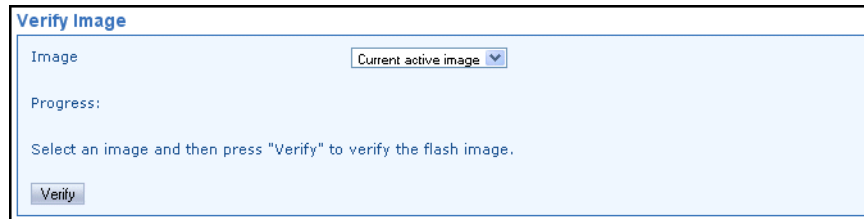

- **Verify**—Click this button to verify the firmware image selected in the drop-down box at the top of the screen. The available selections from the box are: **Current active image**, **Image 1**, **Image 2**, and **Inactive image**.

### Copy Image

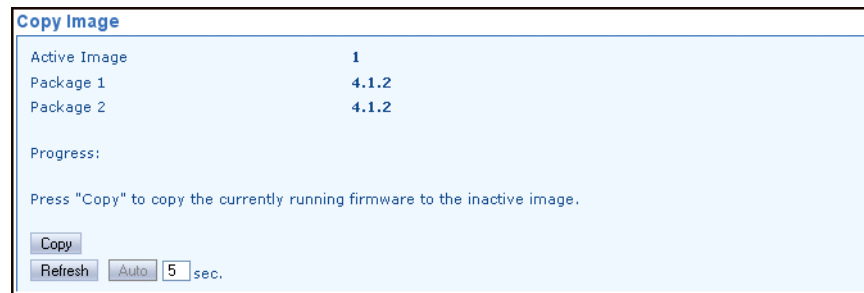

Active Image	1
Package 1	4.1.2
Package 2	4.1.2

- **Active Image**—Shows the firmware package currently being used by the transceiver (1 or 2).
- **Package 1**—Shows the version of firmware package 1.
- **Package 2**—Shows the version of firmware package 2.
- **Copy**—Click this button to copy the currently active firmware to the inactive image.

## Device Reboot

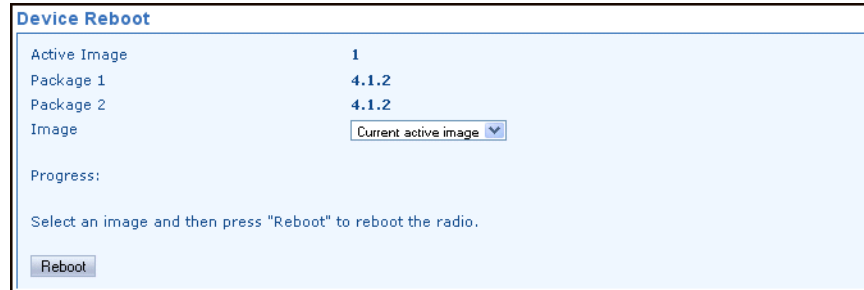

- **Active Image**—Shows the firmware package currently being used by the transceiver (1 or 2).
- **Package 1**—Shows the version of firmware package 1.
- **Package 2**—Shows the version of firmware package 2.
- **Image**—Allows selection of the firmware image to use when rebooting: **Current active Image**, **Image 1**, **Image 2**, **Inactive Image**.
- **Reboot**—Initiates reboot of the radio with the selected firmware image.

## Authorization Codes



This screen allows the entry of a new authorization key to change the enabled features of the radio. The enabled features are not displayed here, but can be viewed using a Serial/Telnet session, under the **Authorization Codes** menu.

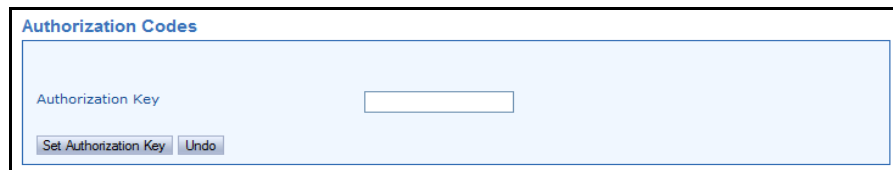

- **Authorization Key**—A factory furnished code used to enable operating features of the transceiver. An error message is returned if an invalid authorization key is entered. Contact your factory representative for ordering details.

## Configuration Files

**NOTE:** It is recommended that users periodically export their configuration file so that it can be loaded back into the radio if their old one requires replacement.

### *Dump/Load Configuration File*

The transceiver provides a Dump/Load Configuration File utility to ease programming of operating parameters. This is especially useful if you have a large number of radios to configure, and want to ensure that each radio is uniformly configured.

**Dump/Load Configuration File**

This menu is used to save or load a configuration text file to/from your computer.

To generate and dump the current configuration file click "Dump Current Configuration".

To upload a configuration file into the radio click "Load Configuration File".

- **Dump Current Config**—Click this button to generate and save the current configuration file being used by the transceiver. You will be prompted for a location to save the file.
- **Load Config File**—Click this button to select a configuration file for loading into the transceiver. You will receive a browse window to help you locate the file on your computer and upload it to the transceiver.

### *TFTP Configuration File*

The **TFTP Configuration File** screen contains settable parameters for TFTP file transfers and also selections for Importing/Exporting configuration Files via TFTP.

**TFTP Configuration File**

Host IP Address

Filename

Timeout (sec)

Click "Export Configuration File" to export the configuration now.

Click "Import Configuration File" to import the configuration now.

- **Host IP Address**—Enter a valid IP address here for the host computer (where the configuration file resides or where you want to send it).
- **Filename**—Enter the exact name of the configuration text file that will be used by the radio to import or export configuration data.
- **Timeout (sec)**—Determines the amount of time in seconds that the radio should wait for a TFTP server to respond. The default setting is 10 seconds, and will not require any change in most cases.
- **Export/Import Config Files** —Choose to export/import a configuration file to/from a local host.

## Save/Restore Configuration

This screen allows saving or restoring a configuration file for the transceiver. Saving a configuration file can be helpful in future troubleshooting tasks, as it allows reverting to a “known good” configuration of the radio.

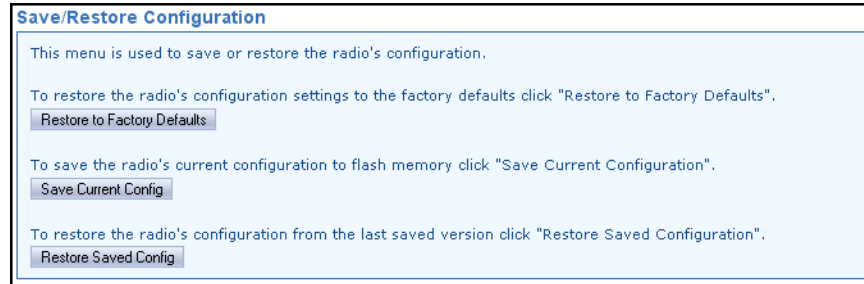

- **Restore to Factory Defaults**—Click this button to restore the radio's configuration settings to the factory defaults.
- **Save Current Config**—Click this button to save the radio's current configuration to flash memory.
- **Restore Saved Config**—Click this button to restore the radio's configuration from the last saved version.

## 7.0 TROUBLESHOOTING

Successful troubleshooting of the radio system requires a logical approach. It is best to begin troubleshooting at the Master unit, as the rest of the system depends on the Master for polling commands. If the Master unit has problems, the overall operation of the network will be affected.

It is good practice to start by checking the simple things. For proper operation, all radios in the network must meet these basic requirements:

- Adequate and stable primary power
- Secure cable connections (power, data and Antenna)
- An efficient and properly aligned antenna system and a received signal strength of at least  $-90$  dBm. (It is possible for a system to operate with weaker signals, but reliability may suffer.)
- The correct interface between the transceiver and the connected data equipment (correct cable wiring, proper data format, timing, etc.)
- Proper programming of the transceiver's operating parameters.

Table 14 provides suggestions for resolving system difficulties that may occur in the radio system. If problems persist, contact the factory for further assistance. Refer to the inside back cover of this guide for contact information.

**Table 14. Troubleshooting Guide**

Difficulty	Recommended System Checks
Unit is inoperative.	<p><b>a.</b> Check for the proper supply voltage at the power connector.</p> <p><b>b.</b> The transceiver's internal fuse may have opened. Factory repair normally required.</p>
Interference or signal overload is suspected.	<p><b>a.</b> Use the Spectrum Analyzer/Graph function to check for interference near the radio channel.</p> <p><b>b.</b> Try re-orienting the station antenna to limit interference to and from other stations.</p> <p><b>c.</b> For excessively strong signals, set RX Signal Attenuation to ON (<b>Configuration&gt;&gt;Radio&gt;&gt;Advanced Settings</b>). Note: Also affects the strength of desired, on-channel signals.</p>

**Table 14. Troubleshooting Guide (Continued)**

No link with Master, or poor overall performance.	<p><b>a.</b> Check for secure interface connections at the radio and the connected device.</p> <p><b>b.</b> Check the antenna, feedline and connectors. Reflected power should be less than 10% of the forward power reading (SWR <math>\approx</math> 2:1 or lower).</p> <p><b>c.</b> If the Remote radio links, but performance is poor, check the received signal strength using the RSSI feature on the <b>Radio Performance</b> screen. If RSSI is low, it may indicate antenna problems, or misalignment of directional antenna headings.</p> <p><b>d.</b> Verify proper programming of system parameters: mode, data interface baud rate, RF output power, etc.</p> <p><b>e.</b> Check for alarms using the <b>Statistics/Events</b> screen.</p>
No communication to user interface (Ethernet system).	<p><b>a.</b> Verify correct IP address is set.</p> <p><b>b.</b> Ensure PC is set to same subnet as radio.</p>
Ethernet port shuts down.	<p><b>a.</b> Excessive data throughput. Do not connect radio to a LAN with high traffic levels.</p> <p><b>b.</b> Auto Power Save is shutting the port down. Disable Auto Power Save on <b>Ethernet Port Configuration</b> screen. (As of this manual's release date, this must be performed using a <i>console terminal session</i>. <i>Device Manager</i> access is planned for a future release.) Note that access to the unit via Ethernet will not be possible if the port is currently shut down.</p> <p><i>About Auto Power Save:</i> This feature, enabled by default, shuts down the Ethernet port if no connection is detected for approximately 10 seconds, such as when a cable is unplugged. Ethernet communications will resume when the connection is restored. If your system experiences Ethernet connection difficulties in operation, the <b>Auto Power Save</b> feature may be disabled. A port that is shut down may also be restored by cycling the radio's DC power input.</p>
No communication to user interface (serial system).	<p><b>a.</b> Connect terminal emulator to COM1 port, cycle power, and press the <b>Enter</b> key within 10 seconds to obtain Login prompt.</p>
BER is too high. Data throughput is spotty.	<p><b>a.</b> If in packet mode, check the <b>Packet Settings</b> screen for proper configuration.</p> <p><b>b.</b> If in serial mode, check the <b>COM1/COM2 Port</b> settings screen for proper configuration.</p>
Latency is too high.	<p><b>a.</b> Adjust packet mode settings.</p>
Unit won't wake up from Sleep Mode.	<p><b>a.</b> Disconnect the device connected to COM2, and disable Sleep Mode on the <b>Device Settings</b> Screen.</p> <p><b>b.</b> Verify that the connected device is outputting the required 0 Vdc to 5 Vdc to control sleep mode on Pin 4 of COM2. Correct as necessary.</p> <p><b>c.</b> Re-enable Sleep Mode on <b>Device Settings</b> Screen, re-connect device to COM2, and check for proper operation.</p>



**Table 14. Troubleshooting Guide (Continued)**

Password lost or forgotten	Contact GE MDS for password reset authorization code. Proof of authorized user required.
Alarm message “RF Output Out of Range”	No load on Antenna connector or poor/shorted/open load. Check condition of antenna cable, connectors, and antenna system.
Transmitter keys when using terminal communications program.	Many terminal programs raise the RTS line by default. Keying can be avoided by setting the transceiver’s <b>RTSkey</b> parameter to <b>OFF</b> ( <b>Configuration&gt;&gt;Radio&gt;&gt;Advanced Settings</b> )

## 7.1 LED Indicators

The LED status indicators are an important troubleshooting aid, and should be checked whenever a problem is suspected. Table 10 on Page 33 describes the function of each status LED and their normal indications.

## 7.2 Checking for Alarms/Events

When an alarm condition exists, the transceiver registers it as an “event.” These events can be viewed the *Device Manager’s Maintenance & Status>>Alarm Summary* screen. Here, you can check for currently active alarms, whether they be Major, Minor, Status Conditions, or Informational Events.

In addition, all historical events may be viewed by accessing the *Device Manager’s Event Log* screen. To access the Event Log, select **Maintenance & Status>>Event Log** and click **Show Log** to view stored events (see Figure 40).

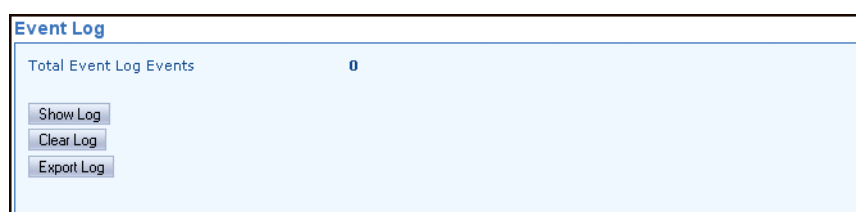

**Figure 40. Event Log Screen**

Both setting and clearing of major/minor alarms and status conditions are logged, as well as informational events (*i.e.*, remote rebooted, reprogramming in process, etc.).

### Major Alarms vs. Minor Alarms

**Major Alarms** report serious conditions that generally indicate a hardware failure, or other abnormal condition that will prevent (or seriously hamper) further operation of the transceiver. Major alarms generally indicate the need for factory repair. Contact your factory representative for further assistance.

**Minor Alarms** report conditions that, under most circumstances will not prevent transceiver operation. This includes out-of-tolerance conditions, baud rate mismatches, etc. The cause of these alarms should be investigated and corrected to prevent system failure.

## Status and Informational Events

**Status** events indicate current states or conditions that are not errors. They are used merely to indicate process functions (*i.e.*, **Reprogramming in Process**).

**Informational** (Inform) events pertain to those items which have occurred since bootup. They may or may not indicate an error, and they do not show current conditions, just an event that occurred at some point after boot-up (*i.e.*, Event #32 **Booting Up**).

## Event Code Definitions

Table 15 contains a listing of event codes that may be reported by the transceiver. The codes shown are a subset of a larger pool of codes used for various GE MDS products. For this reason, the table does not show a sequential listing of *all* code numbers. Only the codes applicable to this product series are shown. This list is subject to change with product revision.

**Table 15. Event Codes**

Event Code	Event Class	Description
000	Major	Not currently implemented.
001	Major	Not currently implemented.
002	Major	Frequency not programmed.
003	Major	Authorization fault detected.
004	Major	RF synthesizer out-of-lock condition.
005	Major	Not currently implemented.
006	Major	Not currently implemented.
007	Major	Not currently implemented.
008	Major	Radio not calibrated. Factory calibration is required for proper operation.
009	Major	DSP download fault.
010	Major	Not currently implemented.
011	Major	Not currently implemented.
012	Major	Receiver time-out. No data received within the specified receiver time-out time.
013	Major	Transmitter time-out.
014	Major	Alarm Test.
015	Major	Not currently implemented.
068	Major	Excessive Ethernet traffic on interface.

**Table 15. Event Codes (Continued)**

Event Code	Event Class	Description
016	Minor	Unit address not programmed.
017	Minor	Not currently implemented.
018	Minor	Not currently implemented.
019	Minor	Not currently implemented.
020	Minor	Not currently implemented.
021	Minor	Not currently implemented.
022	Minor	Not currently implemented.
023	Minor	Not currently implemented.
024	Minor	Not currently implemented.
025	Minor	Not currently implemented.
026	Minor	DC input voltage approaching limit. If the voltage is too far out of tolerance, operation may fail.
027	Minor	Not currently implemented.
028	Minor	Not currently implemented.
029	Minor	RF Output Power not in valid range.
030	Minor	Not currently implemented.
031	Minor	Internal temperature approaching limit.
032	Inform	Booting up.
033	Inform	System initialization complete.
037	Minor	Unexpectedly executing APP 1.
038	Minor	Unexpectedly executing APP 2.
039	Minor	Boot error; active image unknown.
042	Minor	Reprogramming failure.
064	Minor	A socket operation failed.
071	Minor	AP not available.
041	Status	Forced restart of Ethernet interface.
043	Status	Reprogramming in progress.
044	Inform	Firmware update successful.
045	Inform	Reprogramming aborted.
046	Inform	Remote rebooted.

### 7.3 Operating Constraints

The transceiver is a flexible unit offering a wide variety of features needed in the wireless data industry. While many system arrangements and applications are possible, there are a few constraints that system planners should be aware of when designing a radio network. Table 16 lists these constraints and explains how to avoid difficulty in operation.

**Table 16. Operating Constraints**

Constraint	Detailed Information
Minimum firmware version requirement	When operating in “Packet w/MAC” mode, do not downgrade the firmware revision below REV4.0.0. Doing so will cause erratic and unpredictable behavior, including causing the radio to become continuously keyed.
RSSI display in strong signal environments	The RSSI facility limits the maximum displayed signal strength to –60 dBm. Signal levels that are higher than –60 dBm will appear as > -60 dBm.
Radio operation in strong signal environments	Operation with very strong receive signals (> -60 dBm) may require selection of the programmable <b>RX Signal Attenuation</b> feature (see <b>Advanced Settings</b> screen). Some higher bandwidth modems (e.g., 65000) may require further external attenuation if operating at even stronger signal levels (> -35dbm). Note that this is rarely a practical concern; the most likely scenario is in bench testing. Typical field deployments have normal signal strengths well below this threshold.
DC input voltage (SD4)	Early SD4 models supported 10.5 to 16 Vdc power, not 10 to 30 Vdc. Check the labeling above the power connector to confirm the operating range for your unit.

## 8.0 TECHNICAL REFERENCE

### 8.1 Performing Network-Wide Remote Diagnostics

Diagnostics data from a remote radio can be obtained by connecting a laptop or personal computer running GE MDS diagnostic software, such as MDS PulseNET or MDS InSite to any radio in the network. InSite is designed for operation with a serial-based (COM1) connection, unless using a terminal server. PulseNET is designed to operate with the radio's Ethernet port. Figure 41 shows a sample serial arrangement for performing network-wide remote diagnostics.

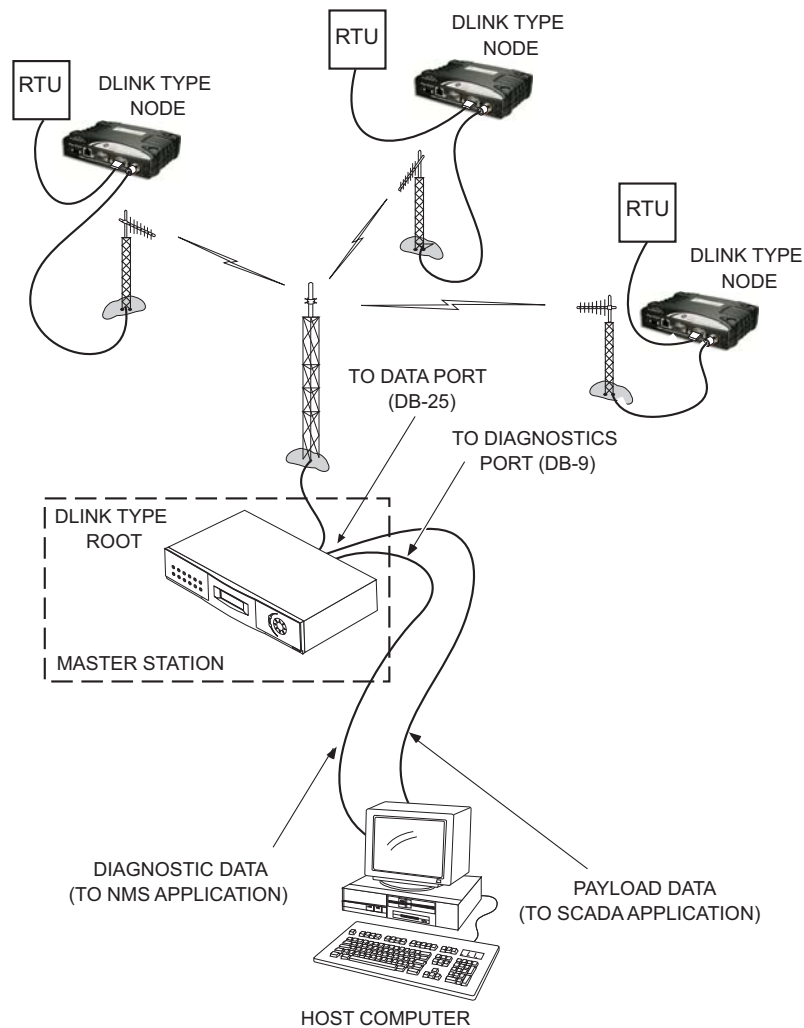

**Figure 41. Network-Wide Remote Diagnostics Setup**

---

**NOTE:** This section of the manual focuses on the use of the radio's Ethernet port for diagnostic configuration (*i.e.*, PulseNET-based diagnostics, or InSite with a terminal server). Alternatively, the COM1 port may be used for serial diagnostics. See the *SD Serial/Telnet Management Supplement*, Part No. 05-6193A01 for more information.

---

With a PC connected to any radio in the network, intrusive polling (polling that interrupts payload data transmission) can be performed. To perform diagnostics *without* interrupting payload data, connect the PC to a radio defined as the “root” radio. This is defined using the *Device Manager* on a connected PC. The following path takes you to the screen where all diagnostic settings are made:

**Configuration>>Radio>>Diagnostic Settings**

To define a radio as the “root” unit, go to the **Dlink Type** box in the Diagnostics **Settings** screen, and select **Root** from the drop-down list.

### Setting Up Diagnostics

The steps below outline the basic procedure of setting up diagnostics for a radio. A more detailed description of remote diagnostics can be found in the Network-Wide Diagnostics System Handbook (05-3467A01).

1. At the AP/Master radio, set the **Dlink Type** to **Root**.
2. Set the **Dlink Type** for all other radios in the network to **Node**.
3. On the root radio, set Dlink TCP Access to **Enabled** on the **Diagnostic Settings Screen**.
4. Connect a PC running the management software to the root radio, or to one of the nodes, using the radio's Ethernet port. (This PC may also be the computer used to collect payload data.)
5. Launch the diagnostic/NMS application at the PC. (Refer to the software user's guide for instructions.)

## 8.2 Over-the-Air Firmware Upgrades

A major feature of the radio is the ability to reprogram remotes in the network without the need to physically visit each radio site. This is accomplished using the over-the-air (OTA) channel. OTA reprogramming always re-programs the “Inactive” firmware image of the radio to ensure that active firmware is not accidentally overwritten.

---

**NOTE:** OTA reprogramming over a narrowband radio channel can be a lengthy process, requiring up to several hours to complete. The time required depends on several factors, as discussed in the following section.

---

### Intrusive vs. Passive (Non-Intrusive) Mode

Firmware code may be transmitted to stations in either intrusive or passive (non-intrusive) mode using the built-in diagnostic capabilities of the radio. When OTA reprogramming is initiated from either a root or node the firmware image is broadcast to *all* Remotes in intrusive or passive use of the channel.

**Intrusive** operation means that the payload application data will be interrupted while programming data is sent over the air. This is the fastest method of programming radios over the air, but it comes at the cost of interruptions in the primary use of the radio network. See Table 17 for the approximate times needed for intrusive reprogramming.

**Table 17. Approximate Reprogramming Times—*Intrusive Mode***

Modem Speed (bps)	Approximate Time Required
4800	1 hour, 30 minutes
9600	35-40 minutes
19200	20-25 minutes

**Radio assumptions:** Signal strength -85 dBm or stronger, Packet Size: 40, Block Size: 512, Retry: 3, Download Delay: Extended-1

**Polling assumptions:** Serial polling with 1-second poll time, sending random data at 50-100 bytes. Slower polling times will significantly increase completion time.  
**Polling should be temporarily suspended while OTA reprogramming is active.**

---

**NOTE:** Intrusive mode should be used only when the radio channel can be devoted to the reprogramming operation, as payload data will be interrupted.

---

**Passive (Non-intrusive)** operation “piggy-backs” reprogramming data onto normal payload data streams, thus allowing payload data to continue uninterrupted. This mode requires payload data to be sent so that the reprogramming data can be carried.

---

**NOTE:** Radio networks configured for Packet w/MAC operation support intrusive operation while still sending payload data. Data is sent at the first chance, and does not wait for user data to be sent.

---

The disadvantage to passive operation is that it takes longer to convey the reprogramming information since it must be attached to existing data transactions. See Table 18 for the approximate times needed for passive reprogramming.

**Table 18. Approximate Reprogramming Times—Passive Mode**

<b>Modem Speed (bps)</b>	<b>Approximate Time Required</b>
4800	6 hours, 7 minutes
9600	1 hour, 30 minutes
19200	1 hour, 30 minutes

***Radio assumptions:** Signal strength -85 dBm or stronger, Packet Size: 40, Block Size: 512, Retry: 3, Download Delay: Extended-1*

***Polling assumptions:** Serial polling with 1-second poll time, sending random data at 50-100 bytes. Slower polling times will significantly increase completion time.*

**NOTE:** It is possible for Remote radios receiving a firmware upgrade to complete reprogramming before the initiating station does. This is because transmissions are sent out “broadcast style” and will be sent up to the number of times entered in the **Retry Count** parameter of the radio. In a strong signal environment, the image may be received successfully the first time, but the initiator does not know this, and continues broadcasting image data blocks until the specified retry count has been reached.

### Broadcast Reprogramming Suggestions by Network Type

Table 19 provides suggested settings for performing Broadcast Reprogramming operations based on the type of network employed. Each system has unique requirements, but experience has shown that these settings provide reasonable performance for the network types listed.

**Table 19. Broadcast Reprogramming—Suggested Settings**

<b>Network Type</b>	<b>Packet Data Size</b>	<b>Retry Count</b>	<b>Block Size</b>	<b>Download Delay</b>
Small Networks (i.e., 10 Remotes or less)	40	3	512	Extended-1
Large Networks (i.e., 11 Remotes or more)	40	6	512	Extended-2
Repeater Networks	40	6	256	Extended-3
Store and Forward Networks	40	6	256	Extended-2



## OTA Reprogramming Overview

The “Root” is the central location from which polling originates. Other locations in the network should be designated as “Nodes” which are the receiving stations. Over-the-air firmware upgrades should always be initiated from the Root. This ensures that all radios in the network will be properly updated.

Once an OTA reprogram session has started, the initiating radio’s user selects either the active or inactive image stored in its non-volatile storage which is copied to all the other radios in the network.

The initiator broadcasts a series of messages to one or more remote Nodes to accomplish the reprogramming process. The “broadcast” method is used to program the greatest number of radios in the shortest amount of time, however, the initiating station remains unaware of the number or success of downstream radios participating in reprogramming.

During reprogramming, the status of the reprogramming will be available on all the radios participating in the process. Because the initiator is “broadcast-only” this status can only indicate progress toward sending out of *all* of the messages. On the Nodes, the progress toward completion of reception of reprogramming information is indicated.

Receiving stations can automatically reboot to the new image after successful reprogramming. Alternatively, there is an OTA reboot command that can be broadcast from the initiator to all receiving stations. This last option instructs the receivers to reboot to a specific firmware revision if available, and not already running at that revision.

## Cancelling OTA Reprogramming

During the reprogramming operation the user has the ability to cancel reprogramming at anytime either on the initiator, which will affect all radios, or on individual receiving stations. Note that cancelling reprogramming at the initiator results in all radios in the network having only one (instead of two) applications programmed in their image banks. That is, the “inactive” image (which was only partially upgraded) and will be corrupt and unusable until reprogrammed at a later time.

## Error Conditions/Recovery

Other than cancelling the reprogramming process, there are few error conditions that the initiator knows or can do anything about. Receiving radios perform checks and verification on the incoming data. If after the end of the reprogramming sequence a radio still has an invalid image (for whatever reason) the radio will *not* reboot but continue running with its active, and valid image.

## Execution and Screen Examples

### User Data Explanations

Displayed information during reprogramming (at Root radios):

- Progress (Percent Complete—Read-only):** This parameter indicates percent complete of a firmware upgrade. The calculation is done each time a block of data is successfully transmitted or received. Must be viewed on the **Reprogramming** screen.

### User Command explanations

Command options available during reprogramming (at Root radios):

- Stop Remote Reprogramming—**Terminate remote firmware upgrade for all remote nodes in the network. Inactive images on non-root radios will be invalid. (No change to status of root radio images)
- Reboot Remote to—**Manually send a reboot to all remote nodes in the network. All remote nodes will reboot to their image selected.

Command options available during reprogramming (at “Non-Root” radios):

- Stop Remote Reprogramming—**Terminate Remote Reprogramming for local radio. Inactive image will be invalid.

### Screen Example

Figure 42 shows the radio’s **Remote Reprogramming** Screen.

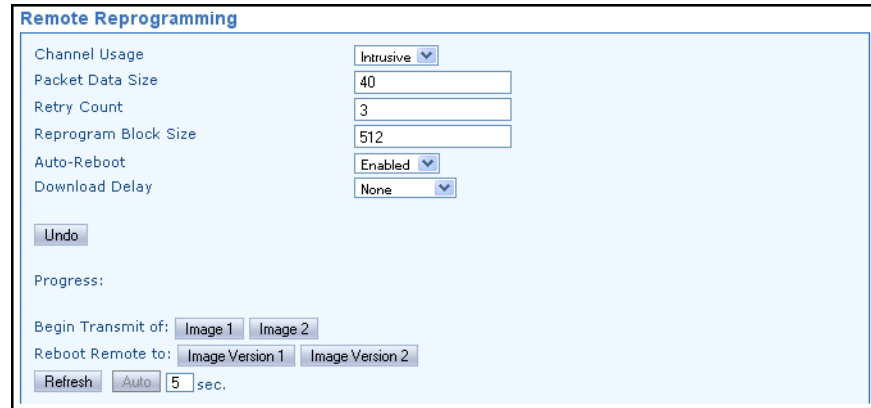

**Figure 42. Remote Reprogramming Screen**

## 8.3 COM1 Operating Modes

The COM1 port can operate in one of several possible modes. From the user's perspective, it can be considered to be in Data mode or Management mode, where user input can be accepted via either a menu interface, a command line interface, or a diagnostic interface such as GE MDS-proprietary DLINK protocol. The list below shows all possible modes for the COM1 port:

- **Console mode**—For serial-based “console terminal” control of the radio. Menu screens are presented where you make selections and apply them with the PC’s keyboard.
- **Data mode**—Where COM1 is used for payload data, and not user control/management of the transceiver.
- **DLINK (diagnostics) mode**—Where a PC running InSite or PulseNET management software is connected to COM1.
- **Command line/scripting mode**—Where text-based commands are used to manage the radio, typically by means of an automated “scripting” system, rather than by manual entry. (Refer to *SD Serial/Telnet Management Supplement*, Part No. 05-6193A01 for a summary of text commands.)

### Changing COM1 Modes

The *Device Manager* may be used to change the COM1 operating mode by accessing the **Configuration>>Communication Ports>>Com 1 Port Settings** screen (see “COM1 Port Settings” on Page 67). Using this screen, the **Startup Mode** and **Current Mode** may be set to either **Console** or **Data** from the drop-down selections.

---

**NOTE:** The COM1 operating mode may also be set using a PC terminal connected directly to the port. See *SD Serial/Telnet Management Supplement*, Part No. 05-6193A01 for details.

---

## 8.4 Implementing Sleep Mode

Sleep Mode places the transceiver into a low power “hibernating” state, with a nominal current draw of less than 12 mA (at 13 Vdc) and a “wake-up” time of approximately 50 milliseconds. Sleep Mode is often used at battery/solar-powered sites to conserve power.

The ability to enter Sleep Mode is controlled through the **Device Settings** Screen (see “Device Settings” on Page 46), but an active low on Pin 4 of the COM2 port is what actually places the radio in Sleep Mode.

---

**NOTE:** Sleep mode is not intended for use on a Master radio.

---

# MDS SD Series

## Secure, Long Range IP/Ethernet & Serial

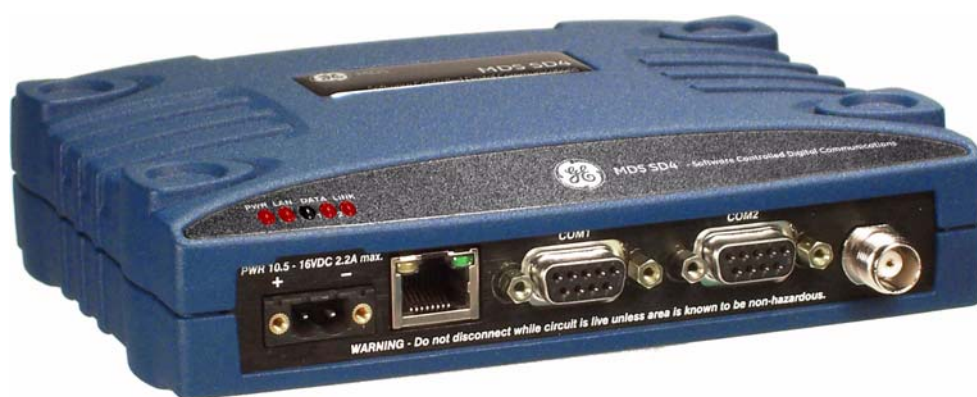

*Covering ES/SS Units with Firmware Version 5.x*

*Applies to all models **EXCEPT** those operated in x710 Mode. For x710 mode operation, refer to Publication 05-4670A01.*

MDS 05-4846A01, Rev. H  
November 2013



Digital Energy  
MDS

*Quick-Start instructions for this product are contained in publication 05-4847A01.*

All GE MDS manuals and updates are available online at **[www.gemds.com](http://www.gemds.com)**.

## **How Sleep Mode Works**

When Sleep Mode is enabled via the Device Settings Screen, the state of Pin 4 on COM2 is continuously monitored to detect a request to enter sleep mode from an external device (RTU, PLC, etc.). For ease of use, there are certain conditions which temporarily override the sleep request to prevent unwanted behavior of the radio. These conditions are:

1. The radio must be powered up for at least 60 seconds before it is allowed to enter sleep mode.
2. Any user-originated activity on the console terminal disables entering sleep mode for 30 seconds, measured from the time of last keystroke.
3. When locally reprogramming the transceiver's firmware, sleep mode is disabled throughout the reprogramming time, and is suppressed for 30 seconds thereafter.
4. The passage of payload data does *not* inhibit sleep mode.

## **Sleep Mode Example**

This section describes how to implement Sleep Mode in a typical scenario. Before using Sleep Mode, the following conditions must be met to provide proper operation and avoid damage to the transceiver:

- a. Sleep Mode must be enabled on the **Radio >> Device Settings** Screen.
- b. Output voltage to the radio must not exceed +5.0 Vdc.
- c. Output voltage to wake up the radio must be between +2.0 Vdc and +5.0 Vdc.
- d. Output voltage to enter Sleep Mode must be +0.6 Vdc or less.

With the above conditions met, you are ready to use Sleep Mode. As a working example, suppose you need communication to each Remote site in your network only once per hour. Program the RTU/PLC at the Remote sites to raise an RS-232 line once each hour (DTR for example), and wait for a poll and response before lowering it again. Connect the RS-232 line to Pin 4 of the radio's COM2 port. This allows each Remote to be polled once per hour with a significant savings in power consumption.

## 8.5 Technical Specifications

### GENERAL

---

Frequency Range:	<b>SD1:</b> 150-174 MHz  <b>SD2:</b> 216-235 MHz in one of the following bands: Band A—216 to 220 MHz Band B—220 to 222 MHz Band C—220 to 235 MHz Band D—216 to 220 MHz (50 kHz B/W)  <b>SD4:</b> 300–512 MHz in one of the following bands: Band A—350 to 400 MHz Band B—400 to 450 MHz Band C—450 to 512 MHz Band D—300-360 MHz  <b>SD9:</b> 820–960 MHz in one of the following bands: Band A—820 to 870 MHz Band B (not currently used) Band C—928 to 960 MHz Band D—928 to 960 MHz (50 kHz B/W) Band E—880 to 915 MHz Band F—880 to 915 MHz (50 kHz B/W) Band G—850 to 860 MHz/926 to 936 TX LO Band H—850 to 860 MHz/926 to 936 TX HI
------------------	---

*Specific frequency authorizations are dependent on the type-approval of the radio. Consult factory for details.*

Occupied Bandwidths:	<b>SD1:</b> 6.25, 12.5, 25.0 kHz <b>SD2:</b> 5.0, 6.25, 9.0, 12.5, 25.0, 50.0 kHz <b>SD4:</b> 6.25, 12.5, 25.0 kHz <b>SD9:</b> 5.0, 12.5, 25.0, 50.0 kHz
----------------------	---

*NOTE: This information subject to change depending on specific modem configuration. For emission designator information, consult the FCC website for latest “GE MDS” grants: <http://transition.fcc.gov/oet/ea/fccid/>. Emission designators are subject to change pending new FCC additions and approvals.*

### RECEIVER

---

Maximum Usable Sensitivity:	−112 dBm at $1 \times 10^{-6}$ BER (9600 BPS)
-----------------------------	---

*NOTE: Typical sensitivity rating at 9600 BPS. See modem type listing in Section 6.0 for detailed ratings.*

### TRANSMITTER

---

Carrier Power:	0.1 Watts to 5 Watts
Power Measurement Accuracy:	+/- 1.5 dB
Duty Cycle:	Continuous
Output Impedance:	50 $\Omega$

FCC ID:	<b>SD1:</b> E5MDS-SD1 <b>SD2:</b> E5MDS-SD2-1 <b>SD4:</b> E5MDS-SD4 <b>SD9:</b> E5MDS-SD9-1
IC ID:	<b>SD1:</b> 101D-SD1 <b>SD2:</b> 101D-SD2-1 <b>SD4:</b> 101D-SD4 <b>SD9:</b> 101D-SD9-1

## DATA CHARACTERISTICS

---

Signaling Types:	RS-232/485; DB-9 Female connector Ethernet 10/100 Mbps; RJ-45F connector
COM2 Data Rates:	300–115200 bps, asynchronous
Data Latency:	11 ms typical (transparent)

## PRIMARY POWER

---

Voltage:	10.0 to 30 Vdc (Negative ground only)
----------	---------------------------------------

*NOTE: Early SD4 models supported 10.5 to 16 Vdc power, not 10 to 30 Vdc. Check the labeling above the power connector to confirm the operating range for your unit.*

TX Supply Current ( <i>Typical</i> ):	2.5 Amperes maximum @ 5 Watts RF Output
RX Supply Current ( <i>Typical</i> ):	<i>Operational</i> —125 mA, Nominal <i>Sleep</i> —<10 mA typical @ 13.8 Vdc
Fuse:	5 Ampere, internal

## ENVIRONMENTAL

---

Humidity:	95%, non-condensing
Temperature Range:	–40 to 70 degrees C (–40°F to 158°F)
Duty Cycle:	50% (ambient temperature, –40C to +70C) Continuous (internal temperature <= +80C)
Weight (nominal):	1.22 lbs. (0.55 kg)
Transceiver Dimensions:	6.5" long (16.51 cm), 4.625" wide (11.75 cm), 1.5" High (3.81 cm)
Mean Time Between Failure (MTBF):	Consult factory for on-file data

## DIAGNOSTICS INTERFACE

---

Signaling Standard:	RS-232 (COM1, DB-9F connector) RS-232/RS-485 (COM2, DB-9F connector)
---------------------	---

***Product specifications are subject to change without notice or obligation to any party.***



## 8.6 dBm-Watts-Volts Conversion Chart

Table 20 is provided as a convenience for determining the equivalent wattage or voltage of an RF power expressed in dBm.

**Table 20. dBm-Watts-Volts Conversion—for 50 Ohm Systems**

dBm	V	Po	dBm	V	Po	dBm	mV	Po	dBm	μV	Po	dBm	μV	Po
+53	100.0	200W	0	.225	1.0mW	-49	0.80		-98	2.9		-98	2.9	
+50	70.7	100W	-1	.200	.80mW	-50	0.71	.01μW	-99	2.51		-99	2.51	
+49	64.0	80W	-2	.180	.64mW	-51	0.64		-100	2.25	.1pW	-100	2.25	.1pW
+48	58.0	64W	-3	.160	.50mW	-52	0.57		-101	2.0		-101	2.0	
+47	50.0	50W	-4	.141	.40mW	-53	0.50		-102	1.8		-102	1.8	
+46	44.5	40W	-5	.125	.32mW	-54	0.45		-103	1.6		-103	1.6	
+45	40.0	32W	-6	.115	.25mW	-55	0.40		-104	1.41		-104	1.41	
+44	32.5	25W	-7	.100	.20mW	-56	0.351		-105	1.27		-105	1.27	
+43	32.0	20W	-8	.090	.16mW	-57	0.32		-106	1.18		-106	1.18	
+42	28.0	16W	-9	.080	.125mW	-58	0.286							
+41	26.2	12.5W	-10	.071	.10mW	-59	0.251							
+40	22.5	10W	-11	.064		-60	0.225	.001μW						
+39	20.0	8W	-12	.058		-61	0.200		-107	1000		-107	1000	
+38	18.0	6.4W	-13	.050		-62	0.180		-108	900		-108	900	
+37	16.0	5W	-14	.045		-63	0.160		-109	800		-109	800	
+36	14.1	4W	-15	.040		-64	0.141		-110	710	.01pW	-110	710	.01pW
+35	12.5	3.2W	-16	.0355					-111	640		-111	640	
+34	11.5	2.5W							-112	580		-112	580	
+33	10.0	2W							-113	500		-113	500	
+32	9.0	1.6W							-114	450		-114	450	
+31	8.0	1.25W							-115	400		-115	400	
+30	7.10	1.0W							-116	355		-116	355	
+29	6.40	800mW							-117	325		-117	325	
+28	5.80	640mW							-118	285		-118	285	
+27	5.00	500mW							-119	251		-119	251	
+26	4.45	400mW							-120	225	.001pW	-120	225	.001pW
+25	4.00	320mW							-121	200		-121	200	
+24	3.55	250mW							-122	180		-122	180	
+23	3.20	200mW							-123	160		-123	160	
+22	2.80	160mW							-124	141		-124	141	
+21	2.52	125mW							-125	128		-125	128	
+20	2.25	100mW							-126	117		-126	117	
+19	2.00	80mW							-127	100		-127	100	
+18	1.80	64mW							-128	90		-128	90	
+17	1.60	50mW							-129	80	.1fW	-129	80	.1fW
+16	1.41	40mW							-130	71		-130	71	
+15	1.25	32mW							-131	61		-131	61	
+14	1.15	25mW							-132	58		-132	58	
+13	1.00	20mW							-133	50		-133	50	
+12	.90	16mW							-134	45		-134	45	
+11	.80	12.5mW							-135	40		-135	40	
+10	.71	10mW							-136	35		-136	35	
+9	.64	8mW							-137	33		-137	33	
+8	.58	6.4mW							-138	29		-138	29	
+7	.500	5mW							-139	25	.01fW	-139	25	.01fW
+6	.445	4mW							-140	23		-140	23	
+5	.400	3.2mW												
+4	.355	2.5mW												
+3	.320	2.0mW												
+2	.280	1.6mW												
+1	.252	1.25mW												

## 9.0 GLOSSARY OF TERMS & ABBREVIATIONS

If you are new to digital radio systems, some of the terms used in this guide may be unfamiliar. The following glossary explains many of these terms and will prove helpful in understanding the operation of the transceiver.

**Active Messaging**—This is a mode of diagnostic gathering that may interrupt payload system polling communications (contrast with *passive messaging*). Active (or intrusive) messaging is faster than passive messaging because it is not dependent upon the RTU polling cycle.

**Antenna System Gain**—A figure, normally expressed in dB, representing the power increase resulting from the use of a gain-type antenna. System losses (from the feedline and coaxial connectors, for example) are subtracted from this figure to calculate the total antenna system gain.

**BER**—Bit Error Rate

**Bit**—The smallest unit of digital data, often represented by a one or a zero. Eight bits (plus start, stop, and parity bits) usually comprise a byte.

**Bits-per-second**—See *BPS*.

**BPS**—Bits-per-second. A measure of the information transfer rate of digital data across a communication channel.

**Bridging**—(see *Ethernet Bridging*)

**Byte**—A string of digital data usually made up of eight data bits and start, stop and parity bits.

**Ckeyed**—Pertains to *continuously keyed* Master stations (full-duplex).

**CTS**—Clear to Send

**Decibel (dB)**—A measure computed from the ratio between two signal levels. Frequently used to express the gain (or loss) of a system.

**Data Circuit-terminating Equipment**—See *DCE*.

**Data Communications Equipment**—See *DCE*.

**Data Terminal Equipment**—See *DTE*.

**dBi**—Decibels referenced to an “ideal” isotropic radiator in free space. Frequently used to express antenna gain.

**dBm**—Decibels referenced to one milliwatt. An absolute unit used to measure signal power, as in transmitter power output, or received signal strength.

**DCE**—Data Circuit-terminating Equipment (or Data Communications Equipment). In data communications terminology, this is the “modem” side of a computer-to-modem connection. The transceiver described in this manual is hardwired as a DCE device.

**Digital Signal Processing**—See *DSP*.

**DLINK**—Data Link Mode. This is a GE MDS-proprietary protocol used when the transceiver is in diagnostics mode.

**DSP**—Digital Signal Processing. The transceiver’s DSP is the core operating unit of the transceiver through which nearly all functions depend.

**DTE**—Data Terminal Equipment. A device that provides data in the form of digital signals at its output. Connects to the DCE device.

**ETH**—Ethernet

**Ethernet Bridging**—A mode of operation for the transceiver where the radio decides whether messages are handled locally or sent intact over-the-air.

**Fade Margin**—The greatest tolerable reduction in average received signal strength expected under most conditions. Provides an allowance for reduced signal strength due to multipath fading, slight antenna movement or changing atmospheric losses. A fade margin of 20 to 30 dB is usually sufficient in most systems.

**FPGA**—Field Programmable Gate Array

**Frame**—A segment of data that adheres to a specific data protocol and contains definite start and end points. It provides a method of synchronizing transmissions.

**Gate**—An operating mode of the transceiver with respect to diagnostic/management activities. See also *NODE*, *PEER*, and *ROOT*.

**Hardware Flow Control**—A transceiver feature used to prevent data buffer overruns when handling high-speed data from the RTU or PLC. When the buffer approaches overflow, the radio drops the clear-to-send (CTS) line, which instructs the RTU or PLC to delay further transmission until CTS again returns to the high state.

**Host Computer**—The computer installed at the master unit, which controls the collection of data from one or more remote sites.

**I/O**—Input/Output

**IP**—Internet Protocol

**Intrusive Diagnostics**—A mode of remote diagnostics that queries and commands radios in a network with an impact on the delivery of the system “payload” data. See *Active messaging*.

**LAN**—Local Area Network

**LED**—Light Emitting Diode

**Latency**—The delay (usually expressed in milliseconds) between when data is applied to TXD (Pin 2) at one radio, until it appears at RXD (Pin 3) at the other radio.

**Listen Before Transmit**—A collision avoidance mechanism that attempts to allow transmission only when the channel is clear.

**mA**—Milliamperes (current flow)

**MAC**—Media Access Control

**MAS**—Multiple Address System. A radio system where a central master unit communicates with several remote stations for the purpose of gathering telemetry data.

**Master (Station)**—Radio which is connected to the host computer. It is the point at which polling enters the network.

**Multiple Address System**—See *MAS*.

**Network-Wide Diagnostics**—An advanced method of controlling and interrogating GE MDS radios in a radio network.

**Node**—An operating mode of the transceiver with respect to diagnostic/management activities. See also *GATE*, *PEER*, and *ROOT*.

**Non-intrusive diagnostics**—See *Passive messaging*.

**OTA**—Over-the-Air

**PA**—Power Amplifier

**Packet Radio**—A transmission scheme in which data elements are assembled into units, that are consecutively numbered and error-checked at the time of transmittal. Errored packets result in retry requests from the receiving station.

**Passive messaging**—This is a mode of diagnostic gathering or reprogramming that does not interrupt payload system polling communications. Diagnostic/reprogramming data is sent/collected non-intrusively over a period of time; polling messages are carried with payload system data (contrast with *active messaging*).

**Payload data**—This is the application’s communication data which is sent over the radio network.

**Peer**—An operating mode of the transceiver with respect to diagnostic/management activities. See also GATE, NODE, and ROOT.

**Point-Multipoint System**—A radio communications network or system designed with a central control station that exchanges data with a number of remote locations equipped with terminal equipment.

**Poll**—A request for data issued from the host computer (or master PLC) to a remote radio.

**PLC**—Programmable Logic Controller. A dedicated microprocessor configured for a specific application with discrete inputs and outputs. It can serve as a host or as an RTU.

**PPM**—Parts per Million

**Programmable Logic Controller**—See *PLC*.

**Remote (Station)**—A radio in a network that communicates with an associated master unit.

**Remote Terminal Unit**—See *RTU*.

**Redundant Operation**—A station arrangement where *two* transceivers and two power supplies are available for operation, with automatic switch-over in case of a failure.

**Root**—An operating mode of the transceiver with respect to diagnostic/management activities. See also GATE, NODE, and PEER.

**RTS**—Request-to-send

**RTU**—Remote Terminal Unit. A data collection device installed at a remote radio site. An internal RTU *simulator* is provided with the transceiver to isolate faults to either the external RTU or the radio.

**RX**—Abbreviation for “Receive.” See also TX.

**SAF**—Store and Forward. An available feature of the radio where data is stored by a designated Remote, and then retransmitted to a station beyond the communication range of the AP.

**Signal-to-Noise Ratio**—See *SNR*.

**SCADA**—Supervisory Control And Data Acquisition. An overall term for the functions commonly provided through an MAS radio system.

**SNR**—Signal-to-Noise ratio. A measure of how well the signal is being received at a radio relative to noise on the channel.

**Standing Wave Ratio**—See *SWR*.

**Supervisory Control And Data Acquisition**—See *SCADA*.

**SWR**—Standing Wave Ratio. A parameter related to the ratio between forward transmitter power and the reflected power from the antenna system. As a general guideline, reflected power should not exceed 10% of the forward power ( $\approx 2:1$  SWR).

**Telnet**—A terminal emulation protocol that enables an Internet user to communicate with a remote device for management activities as if it were locally connected to a PC.

**Terminal Server**—An available feature on the radio which encapsulates serial data from the COM1/COM2 ports, and sends it over the air as IP packets. The data is decapsulated at the receiving end and routed to the appropriate COM ports.

**Transparent Mode**—A mode in which payload data is unchanged from its original format when it is sent over the air. A radio in this mode is said to be “transparent” to connected equipment at each end of a link.

**TX**—Abbreviation for “Transmit.” See also *RX*.

**VLAN**—Virtual Local Area Network

**WAN**—Wide Area Network

**x710**—The generic name for GE MDS legacy transceiver-family products, including the MDS 9710 (900 MHz), MDS 4710 (400 MHz), 2710 (200 MHz) and MDS 1710 (100 MHz).







# INDEX

## A

- Active messaging (defined) 104
- Alarms
  - alarm code definitions 90
  - major vs. minor 89
- Antenna
  - installation 28
  - system gain, defined 104
  - Yagi, illustrated 21
- Antennas 20–21
- Applications
  - point-to-point system 12

## B

- Bits-per-second. See BPS 104
- BPS (bits-per-second), defined 104
- Byte, defined 104

## C

- Cable
  - maximum length, recommended 26, 27
  - Cable, loss due to length of coaxial at 960 MHz 22
- Cautions
  - use attenuation between all units in test setup 93
- connectors 23
- Conversions, dBm-Watts-Volts 108

## D

- Data Circuit-terminating Equipment—See DCE 104
- Data Communications Equipment—See DCE. 104
- Data Terminal Equipment—See DTE 104
- dB. See Decibel 104
- dBi, defined 104
- dBm, defined 105
- DCE (Data Circuit-terminating Equipment), defined 105
- Decibel (dB), defined 104
- Description, product 3, 4
- Diagnostics
  - interface specifications 102
  - network-wide, performing 93, 99, 102
  - PC software used for 94
  - using InSite software for network-wide 93
- Digital Signal Processing—See DSP. 105
- DIN Rail Mounting Bracket 8
- Downloading new software 94
- DSP (Digital Signal Processing), defined 105
- DTE (Data Terminal Equipment), defined 105

## E

- Environment specifications 102
- Equalization, defined 105

## F

- Fade margin, defined 105
- Feedlines 21
- Frame, defined 105

## G

- Glossary 104

## H

- Half-duplex 12

- Hardware flow control, defined 105
- Host computer, defined 105

## I

- Illustrations
  - antenna, Yagi 21
  - MAS network 12, 16
  - network-wide diagnostics 93
  - point-to-point link 13
  - remote station arrangement 18
- InSite software
  - using to perform remote diagnostics 93
- Installation
  - antenna 28
  - power 28
  - power connection 22
- Interference
  - troubleshooting 87
- Intrusive diagnostics (defined) 106

## L

- Latency, defined 106
- LEDs
  - PWR 33
  - status indicators, illustrated 33
- Loss. See Signal

## M

- MAS (Multiple Address System)
  - defined 106
  - illustration 12, 16
- Master Station
  - defined 106
- Model number codes 8
- Mounting instructions 19
- Multiple Address System—See MAS. 106

## N

- Network-wide diagnostics
  - active messaging, defined 104
  - defined 106
  - illustrated 93
  - intrusive diagnostics, defined 106
  - passive messaging (defined) 106
  - procedures 93, 99, 102
- Non-intrusive diagnostics—See Passive messaging. 106

## O

- Operation
  - environment specifications for 102

## P

- Passive messaging (defined) 106
- Payload data (defined) 107
- PLC (Programmable Logic Controller), defined 107
- Point-to-point
  - link, illustrated 13
  - system 12
- Poll, defined 107
- port
  - LAN 23
- Power
  - connection 22
  - installing 28

- LED status indicator (PWR LED) 33
- RF, chart for converting dBm-Watts-Volts 108
- specifications 102
- Procedures
  - checking for alarms (STAT command) 89
  - downloading new software 94
  - mounting the transceiver 19
  - network-wide diagnostics 93, 99, 102
  - troubleshooting 87–91
- Product
  - description 3, 4
  - model number codes 8
- Protected Network Station
  - definition of 8
- PWR
  - LED 33
- R**
- Radio
  - Configuration Software 94
  - inoperative (troubleshooting chart) 87
  - no synchronization with master (troubleshooting chart) 88
  - poor performance (troubleshooting chart) 88
- Receiver
  - specifications 102
  - system specifications 101
- Redundant operation, defined 107
- Remote
  - Station, defined 107
  - Station, illustrated 18
- RTU (Remote Terminal Unit)
  - defined 107
- S**
- SCADA (Supervisory Control And Data Acquisition),
  - defined 107
- Signal
  - loss due to coaxial cable length at 960 MHz, table 22
- Simplex 12
- Sleep mode
  - shown by PWR LED status indicator 33
- Software
  - diagnostics and control used from PC 94
  - upgrading 94
- Specifications
  - diagnostics interface 102
  - environment 102
  - power 102
  - receiver 102
  - receiver system 101
  - transmitter 101
  - transmitter system 101
- Standing Wave Ratio—See SWR. 107
- Supervisory Control And Data Acquisition—See SCADA. 108
- SWR (Standing Wave Ratio), defined 108
- T**
- Tables
  - alarm code definitions 90
  - conversions, dBm-Watts-Volts 108
  - LED status indicators 33
  - length vs. loss in coaxial cables at 960 MHz 22
  - troubleshooting 87
- Technical reference 91–103
- Transceiver
  - diagnostics using PC software 94
  - mounting 28
  - mounting instructions 19
  - upgrading software 94
- Transmitter
  - specifications 101
  - system specifications 101
- Troubleshooting 87–91
  - performing network-wide diagnostics 93, 99, 102
  - STAT command (Status) 89
  - table 87
  - using PC software for 94

## ***IN CASE OF DIFFICULTY...***

---

GE MDS products are designed for long life and trouble-free operation. However, this equipment, as with all electronic equipment, may have an occasional component failure. The following information will assist you in the event that servicing becomes necessary.

### **TECHNICAL ASSISTANCE**

---

Technical assistance for GE MDS products is available from our Technical Support Department during business hours (8:30 A.M.–6:00 P.M. Eastern Time). When calling, please give the complete model number of the radio, along with a description of the trouble/symptom(s) that you are experiencing. In many cases, problems can be resolved over the telephone, without the need for returning the unit to the factory. Please use one of the following means for product assistance:

Phone: 585 241-5510

E-Mail: [gemds.techsupport@ge.com](mailto:gemds.techsupport@ge.com)

FAX: 585 242-8369

Web: [www.gemds.com](http://www.gemds.com)

### **FACTORY SERVICE**

---

Component level repair of equipment is not recommended in the field. Many components are installed using surface mount technology, which requires specialized training and equipment for proper servicing. For this reason, the equipment should be returned to the factory for any PC board repairs. The factory is best equipped to diagnose, repair and align your unit to its proper operating specifications.

If return of the equipment is necessary, you will be issued a Service Request Order (SRO) number. The SRO number will help expedite the repair so that the equipment can be repaired and returned to you as quickly as possible. Please be sure to include the SRO number on the outside of the shipping box, and on any correspondence relating to the repair. No equipment will be accepted for repair without an SRO number.

A statement should accompany the unit describing, in detail, the trouble symptom(s), and a description of any associated equipment normally connected to it. It is also important to include the name and telephone number of a person in your organization who can be contacted if additional information is required. *Note: A backup copy of the product's programming code should be retained (if applicable), as units are normally returned from the factory in a default state.*

The unit must be properly packed for return to the factory. The original shipping container and packaging materials should be used whenever possible. All factory returns should be addressed to:

GE MDS, LLC  
Product Services Department  
(SRO No. XXXX)  
175 Science Parkway  
Rochester, NY 14620 USA

When repairs have been completed, the equipment will be returned to you by the same shipping method used to send it to the factory. Please specify if you wish to make different shipping arrangements. To inquire about an in-process repair, you may contact our Product Services Group using the telephone, Fax, or E-mail information given above.



Digital Energy  
MDS

GE MDS, LLC  
175 Science Parkway  
Rochester, NY 14620  
Telephone: +1 585 242-9600  
FAX: +1 585 242-9620  
[www.gemds.com](http://www.gemds.com)

