

**A**

## User Interface:



**Switch on / off. For switching off please press button for approx. 5 sec.**



**Activates the background lighting**

To navigate through the different menus please use the keys located on the left and right beside the display.

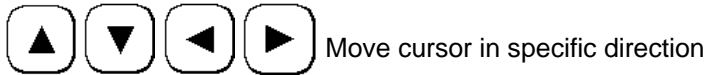

Move cursor in specific direction



Confirm your settings



Confirm your settings and moves to next menu



Back to previous menu



Increase of values



Decrease of values



Activates a certain function (depending on chosen menu)



No function

**B**

## Set-up your flow measurement in 5 steps

1. **Choose suited mounting position for your transducers**
2. **Parameterize your flow transmitter**
3. **Mounting of ultrasonic transducers on your pipe**
4. **Set zero point (if possible)**
5. **Start your flow measurement**



Pipe needs to be filled completely for clamp-on measurement

## Parameterization and mounting

1. Switch on flow transmitter
2.  Choose menu „quick setup“
3. Select diameter or circumference (depending on what figure you have) of your pipe
4. Insert value for diameter or circumference
5. Insert value for wall thickness of your pipe
6. Select pipe material
7. Select lining (if there is a lining)
8. Select type of ultrasonic transducer
  - DUC-WP 21 DN15...DN100
  - DUC-WP10 DN32...DN400
  - DUC-WP05 DN200...DN6000
9. Select method of mounting. Standard is V-mounting.
10. Now the display is showing the required distance between the two transducers in mm and also as Index-No. Index-No. shows the distance (in "holes") when using the spacer bar. When using horizontal pipe we recommend mounting the transducers at 10 o'clock or 2 o'clock position to avoid any influence of gas bubbles that might accumulate on top of pipe. Straight run should be 10x diameter (inlet) and 3x diameter (outlet) in order to achieve best accuracy.

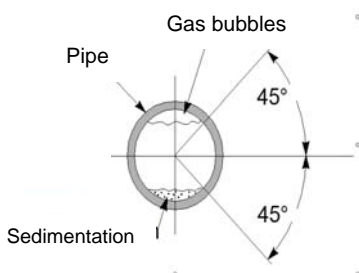

### Mounting without spacer bar:

Please use the distance given in mm. Distance is calculated from inner fronts of the 2 transducers

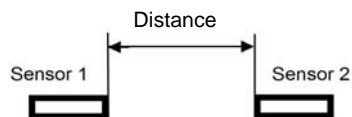

### Mounting with spacer bar:

After parameterization the display is showing the required distance between the two transducers in mm and also as Index-No. Index-No. means the number of holes to be used for mounting with the spacer bar. The first hole **after the first transducers** is hole No. 1, the last hole is the hole where second transducer is put into the spacer bar (threaded bar with milled screws). See picture for example.

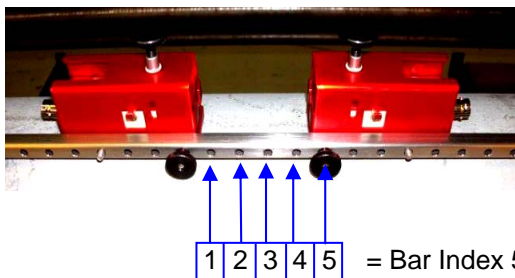



### Fix transducers

**Please always give some coupling grease on surface of transducers before mounting.** Please loosen milled screw. Please fix transducers with chains (only little contact pressure). Then screw the transducers towards pipe by using milled screw. Also only little contact pressure is required.



The displayed bar index is only valid in combination with the correct spacer bar type (long or short)

11. Set Zero Point (if possible)
  - If there is the chance to stop flow please do it and then select „Zero Setup“ and set zero point. 
12. Go back to main menu and select button „MEAS“. You then entering the measuring menu where you see the calculated flow, velocity,.... 

Change units:

->Go to main menu and select SETUP -> COMPL SETUP. Then select „UNITS SETUP“ to change units.

**Manufactured and sold by:**

Kobold Messring GmbH  
 Nordring 22-24  
 D-65719 Hofheim  
 Tel.: +49(0)6192-2990  
 Fax: +49(0)6192-23398  
 E-Mail: info.de@kobold.com  
 Internet: [www.kobold.com](http://www.kobold.com)

**Version K01/0915**



# DUC-MF1 *Quickstart*

**A**

## User Interface

DUC-MF1 will be switched on automatically after supply voltage has been plugged on.



**Activates / deactivates the background lighting**

To navigate through the different menus please use the keys located on the left and right beside the display.



Move cursor in specific direction



Confirm your settings



Confirm your settings and moves to next menu



Back to previous menu



Increase of values



Decrease of values



Activates a certain function (depending on chosen menu)



No function

**B**

## Set-up your flow measurement in 5 steps

1. Choose suited mounting position for your transducers
2. Parameterize your flow transmitter
3. Mounting of ultrasonic transducers on your pipe
4. Set zero point (if possible)
5. Start your flow measurement



Pipe needs to be filled completely for clamp-on measurement

**C**

## Parameterization and mounting

1. Switch on flow transmitter (automatically when plugging on supply voltage, see below)
2.  Choose menu „quick setup“
3. Select diameter or circumference (depending on what figure you have) of your pipe
4. Put in value for diameter or circumference
5. Put in value for wall thickness of your pipe
6. Select pipe material
7. Select lining (if there is a lining)
8. Select type of ultrasonic transducer
  - Nr. 1 = DUC-WF-21 DN10.....DN100
  - Nr. 2 = DUC-WF-10 DN32.....DN400
  - Nr. 3 = DUC-WF-05 DN200...DN6000
9. Select method of mounting. Standard is V-mounting.

## 10. Mount ultrasonic transducers on a pipe

After parameterization the display is showing the required distance between the two transducers in mm and also as Index-No. Index-No. means the number of holes to be used for mounting with the spacer bar. The first hole after the first transducers is hole No. 1, the last hole is the hole where second transducer is put into the spacer bar (threaded bar). Picture 3 shows an example for an index-No. 4.

Together with DUC-MF1 unit itself you will get one pair DUC-WF transducers and a spacer bar which matches together with the delivered DUC-WF transducers.

If you have ordered more DUC-MF1 units and DUC-WF transducers for different pipe diameters it could be that you get spacer bars with different length (short or long). Pls. see in the chart below which spacer bar could be operated together with the corresponding transducer model.

Spacer bar	DUC-WF10	DUC-WF21
Short (25 cm)		X
Long (40 cm)	X	

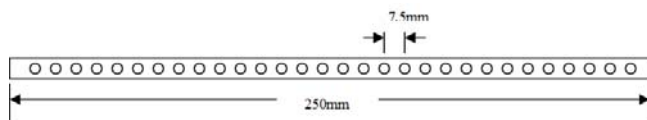

Picture 1 spacer bar short (length 250mm, grid hole distance 7,5mm)

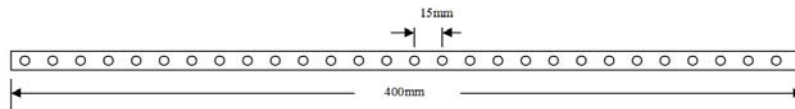

Picture 2 spacer bar „long“ (length 400mm, grid hole distance 15mm)

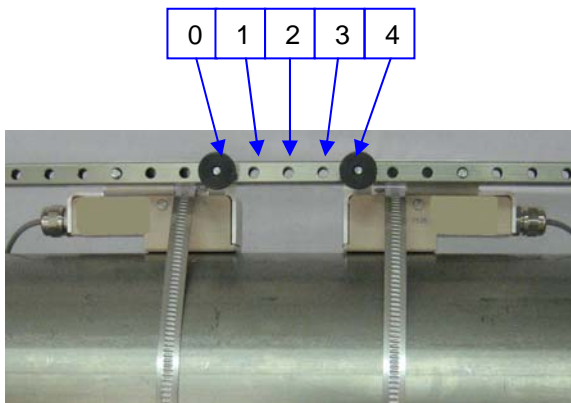

Picture 3 Example distance for bar index four using spacer bar for mounting

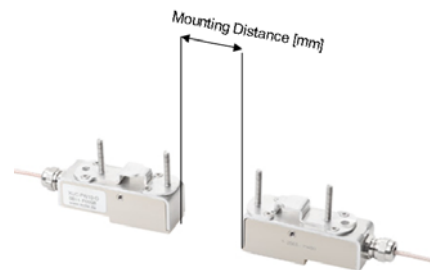

Picture 4 example for distance in mm without using spacer bar(V or W mode) face to face

## 11. Some acoustic coupling gel (app. size of a peanut, picture 5) or acoustic coupling foil has to be put at the part which touches the pipe wall after installation (picture 6). Acoustic coupling foil is standard.

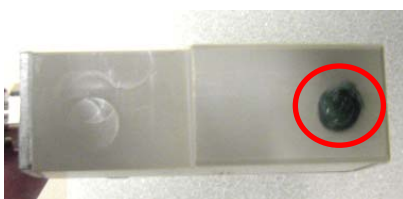

Picture 5 Using acoustic coupling gel (Magnalube)



Picture 6 Using acoustic coupling foil

12. Chose best location for DUC-WF transducer installation.

Straight run should be 10x diameter (inlet) and 3x diameter (outlet) in order to achieve best accuracy. When using horizontal pipe we recommend mounting the transducers at 10 o'clock or 2 o'clock position to avoid any influence of gas bubbles / sedimentation might accumulated on top / on bottom of pipe

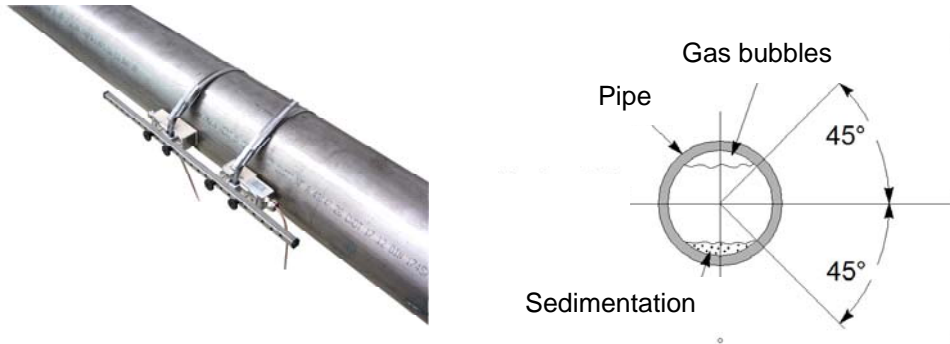

Picture 6 Example Mounted Transducers with spacer bar and mounted at app. 9 o'clock

13. The transducers are fixed to the pipe by using metal belts. The metal belts are tightened by using tightener (picture in the middle). The length of the belt is designed for the biggest pipe size that the transducer can cover. So for (significantly) smaller pipes it might be reasonable to shorten the belts in order to make tightening easier. Please feed the belt into the tightener as shown in picture on the left. Proceed in the same way for PT100. Put between PT100 and surface of the pipe also acoustic coupling gel in between. After installation, PT100 should be insulated to minimize the influence of ambient air temperature.



Pictures 7 Mounting DUC-WF Transducers, PT100 with stainless steel belts on a pipe

11 Set Zero Point (if possible) 

→ If there is the chance to create „zero flow“ please select „Zero Setup“ and set zero point.

12. Go back to main menu and select button „MEAS“ . You enter the measuring menu where you see the calculated flow, velocity,....

Change units:

->Go to main menu and select SETUP -> COMPL SETUP. Then select „UNITS SETUP“ to change units.

13. Activate Outputs

->Go to main menu and select SETUP -> COMPL SETUP. Then select „I/O-SETUP“ and set digital and/or analogue outputs.

Please check DUC-MF1 user manual for further information. The user manual can be found as pdf-document on the CD which is included in the delivery.

## Wiring

To perform the wiring it is necessary to remove the cable cover from DUC-MF1 by removing the two screws (marked with red arrows, picture 8)



Picture 8 Removing cover plate from cable terminal

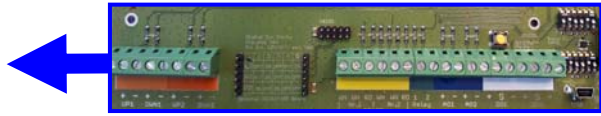

Picture 9 screw terminals

**Power Supply (AC or DC → pls. see type plate)**

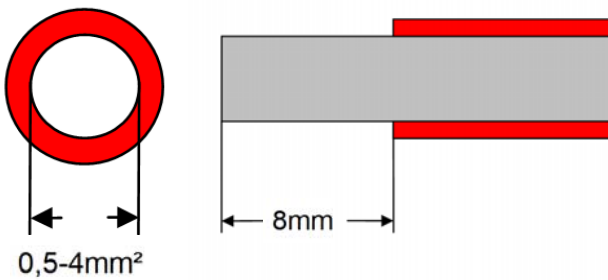

For power supply please use cables with a cross section of ca. 0.5...4 mm<sup>2</sup>. Solid cables should be dismantled about 8 mm to allow proper contact to terminals.

**I/O Terminal**

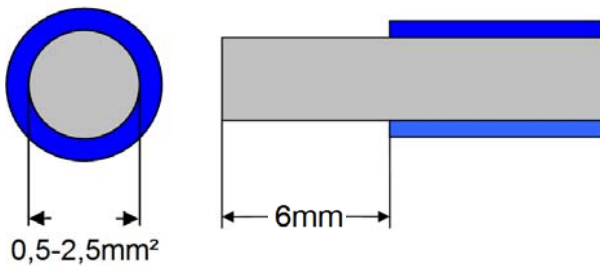

For I/O terminals please use cables with a cross section of ca. 0.5...2.5 mm<sup>2</sup>. Solid cables should be dismantled about 6mm to allow proper contact to terminals.

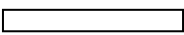
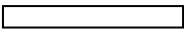
Terminalname	Colour	Description
UP1	ORANGE 	Connection for upstream transducer (red cable = + / black cable = -), Channel 1
DWN1		Connection for downstream transducer (red cable = + / black cable = -), Channel 1
UP2 (only 2 channel version)	RED 	Connection for upstream transducer (red cable = + / black cable = -), Channel 2
DWN2 (only 2 channel version)		Connection for downstream transducer (red cable = + / black cable = -), Channel 2

PT100 No. 1	YELLOW <input type="text"/>	Input for temperature sensor. Left terminal is for the „colder“ temperature (return pipe)
PT100 No. 2		Input for temperature sensor. Right terminal is for the „hotter“ temperature (feed pipe)
Relay	GREEN <input type="text"/>	Relay, potential-free
AO1 4-20mA	BLUE <input type="text"/>	Analogue output 1 (4...20 mA), active, 24 VDC
AO1 4-20mA		Analogue output 2 (4...20m A), active, 24V DC
Digital out DO1	WHITE <input type="text"/>	Universal digital output 1 (transistor), <b>for configuration of the digital outputs pls. read the user main manual.</b>
Digital out DO2 (only 2 channel version)		Universal Digital output 2 (transistor), <b>for configuration of the digital outputs pls. read the user main manual.</b>
Power Supply		Please provide either 90-240 VAC or 18-36 VDC (depending on chosen model). Please make sure that you use the correct voltage. <b>Flow transmitter might be damaged when using wrong supply.</b>

**Note: All in- and outputs (except relay) have defined potential on the internal devices ground. For potential free operation of the in- and outputs is additional hardware needed (with galvanic isolation). With the normal in- and output it is not possible.**

**Manufactured and sold by:**

Kobold Messring GmbH  
 Nordring 22-24  
 D-65719 Hofheim  
 Tel.: +49(0)6192-2990  
 Fax: +49(0)6192-23398  
 E-Mail: info.de@kobold.com  
 Internet: www.kobold.com

**Version K01/0915**

**A**

## User Interface

DUC-MF2 will be switched on automatically after supply voltage has been plugged on.



Activates / deactivates the background lighting

To navigate through the different menus please use the keys located on the left and right beside the display.



Move cursor in specific direction



Confirm your settings



Confirm your settings and moves to next menu



Back to previous menu



Increase of values



Decrease of values



Activates a certain function (depending on chosen menu)



No function

**B**

## Set-up your flow measurement in 5 steps

1. Choose suited mounting position for your transducers
2. Parameterize your flow transmitter
3. Mounting of ultrasonic transducers on your pipe
4. Set zero point (if possible)
5. Start your flow measurement



Pipe need to be filled completely for clamp-on measurement

**C**

## Parameterization and mounting

1. Switch on flow transmitter (automatically when plugging on supply voltage, see below)
2.  Choose menu „quick setup“
3. Select measurement channel 1 or 2
4. Select diameter or circumference (depending on what figure you have) of your pipe
5. Put in value for diameter or circumference
6. Put in value for wall thickness of your pipe
7. Select pipe material
8. Select lining (if there is a lining)
9. Select type of ultrasonic transducer
  - Nr. 1 = DUC-WF21 DN10.....DN100
  - Nr. 3 = DUC-WF10 DN32.....DN400
  - Nr. 4 = DUC-WF05 DN200...DN6000
10. Select method of mounting. Standard is V-mounting.



### 11. Mount ultrasonic transducers on a pipe

After parameterization the display is showing the required distance between the two transducers in mm and also as Index-No. Index-No. means the number of holes to be used for mounting with the spacer bar. The first hole after the first transducers is hole No. 1, the last hole is the hole where second transducer is put into the spacer bar (threaded bar). Picture 3 shows an example for an index-No. 4.

Together with DUC-MF2 unit itself you will get one pair US- transducers and a spacer bar with matches together with the delivered US- transducers .

If you have ordered more DUC-MF2 units and US- transducers for different pipe diameters it could be that you got spacer bars with different length (short or long). Pls. see in the chart below which spacer bar could be operated together with the corresponding transducer model.

Spacer bar	DUC-WF10	DUC-WF21
Short (25 cm)		X
Long (40 cm)	X	

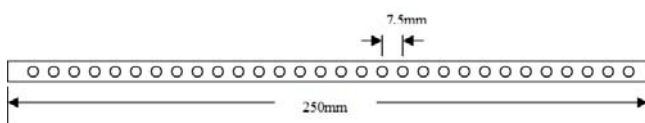

Picture 1 spacer bar short (length 250mm, grid hole distance 7,5mm)

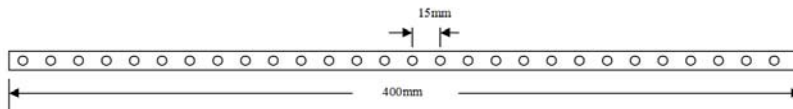

Picture 2 spacer bar „long“ (length 400mm, grid hole distance 15mm)

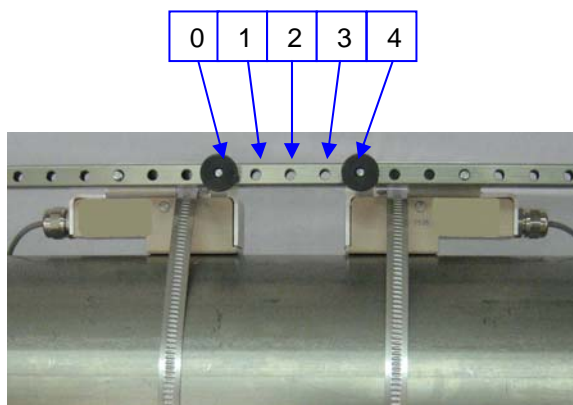

Picture 3 Example distance for bar index four using spacer bar for mounting

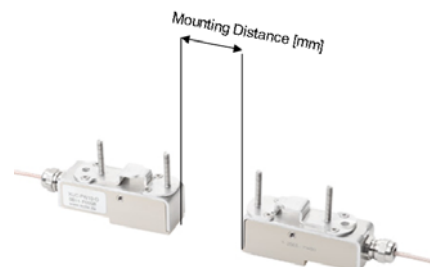

Picture 4 example for distance in mm without using spacer bar(V or W mode) face to face

Some acoustic coupling gel (app. size of a peanut, picture 5) or acoustic coupling foil has to be put at the part which touches the pipe wall after installation (picture 6).

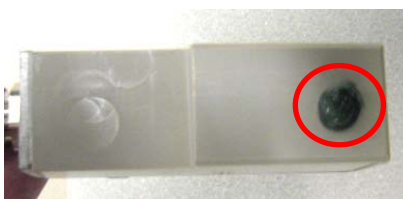

Picture 5 Using acoustic coupling gel (Magnalube)



Picture 6 Using acoustic coupling foil

12. Chose best location for US- transducer installation.

If you install one pair of transducers on each pipe straight run should be 10x diameter (inlet) and 3x diameter (outlet) in order to achieve best accuracy. If you install 2 pairs of transducers on the same pipe it could be used to; increase accuracy, for redundant operation or to reduce effects of flow inclination (see pictures 8 and 9). It is mandatory that both transducers are installed exactly shifted about 180°.

When using horizontal pipe we recommend mounting the transducers at 10 o'clock or 2 o'clock position to avoid any influence of gas bubbles / sedimentation might accumulated on top / on bottom of pipe.

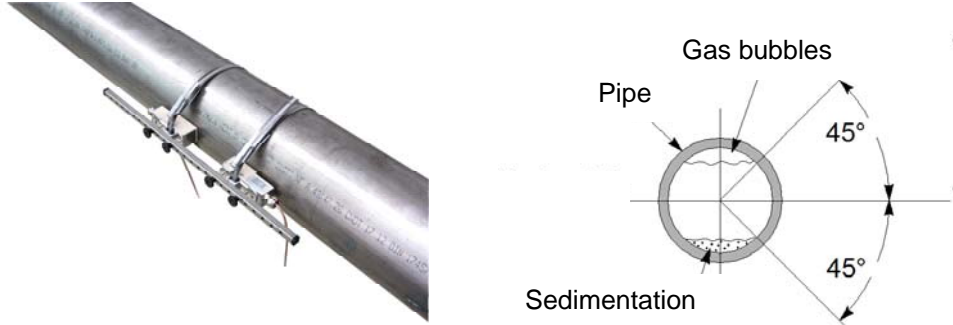

Picture 7 Example Mounted Transducers with spacer bar and mounted at app. 9 o'clock

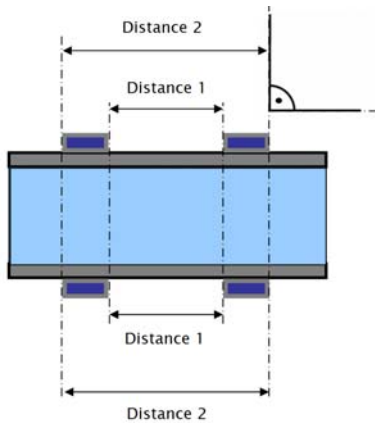

$$U_{1/2} = \frac{2 \cdot \pi \cdot r}{2}$$

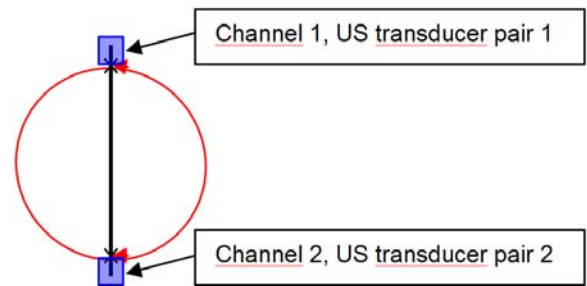

Picture 8 Example two transducer pairs on the same pipe to increase accuracy or to reduce effects of flow inclination or for redundant operation.

Picture 9 Example two transducer one line. Second transducer pair lies exactly 180° shifted to the first transducer pair

13. The transducers are fixed to the pipe by using metal belts. The metal belts are tightened by using tightener (picture in the middle). The length of the belts are designed for the biggest pipe size your transducer can cover. Please feed the belt into the tightener as shown in picture on the left. Proceed in the same way for PT100. **PT 100 Nr. 2 must be installed on the hotter pipe. PT Nr. 1 on the colder pipe. Put between PT100 and surface of the pipe also acoustic coupling gel in between. PT100 should after installation insulated tom minimize the influence from ambience air temperature.**



Pictures 10 Mounting US- Transducers, PT100 with stainless steel belts on a pipe

### 11 Set Zero Point (if possible)

→ If there is the chance to create „zero flow“ please select „Zero Setup“ and set zero point.

12. Go back to main menu and select button „MEAS“ . You then entering the measuring menu where you see the calculated flow, velocity,....

### Change units:

->Go to main menu and select SETUP -> COMPL SETUP. Then select „UNITS SETUP“ to change units.

### 13. Activate Outputs

->Go to main menu and select SETUP -> COMPL SETUP. Then select “I/O-SETUP” and set digital and/or analog outputs.

Please check DUC-MF2 user manual for further information. The user manual can be found as pdf-document on the CD which is included in the delivery.

## Important Notice!

Heat transfer measurement:	Works only in operation mode (CH1+CH2)/2
----------------------------	--

Two transducers on the same pipe:

Increasing accuracy:	Works only in operation mode (CH1+CH2)/2
----------------------	--

Reducing flow inclination	Works only in operation mode (CH1+CH2)/2
---------------------------	--

### Wall mount of DUC-MF2

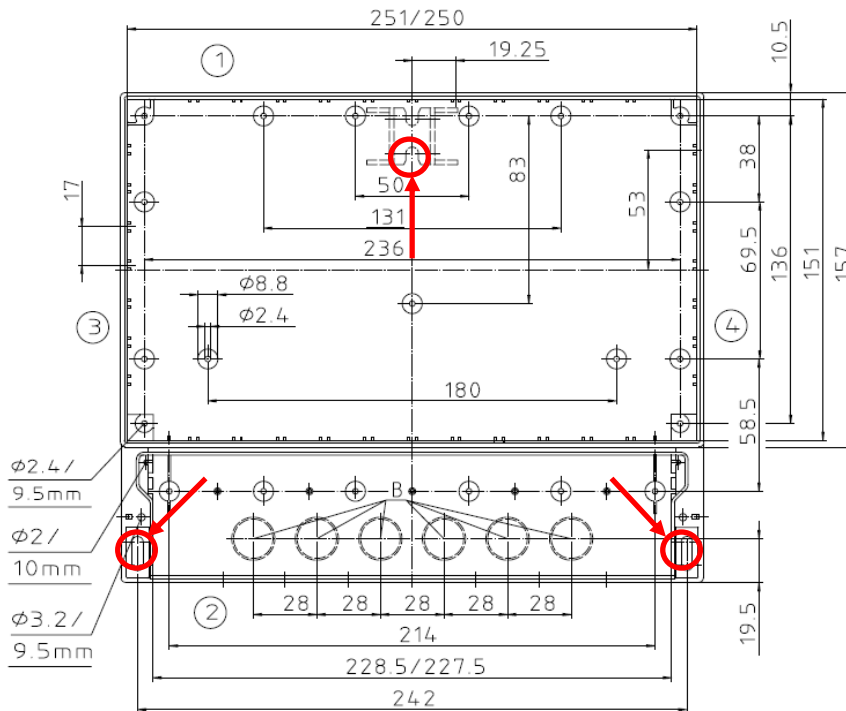

To mount DUC-MF2 on a wall please create three boreholes corresponding to the red marked points on the drawing (all length specifications are metric).

## Wiring

To perform the wiring it is necessary to remove the cable cover from DUC-MF2 by removing the two screws (marked with red arrows, picture 11)

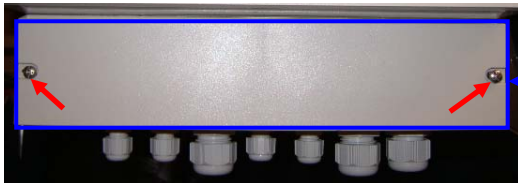

Picture 11 Removing cover plate from cable terminal

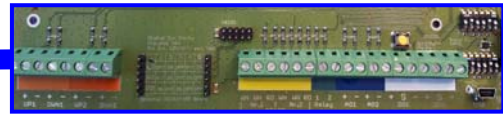

Picture 12 screw terminals

Before you install the ultrasonic sensor cables to the measurement transducer we highly recommend pulling the sensor cable endings through the delivered ferrites. Loop the cable once as shown in the photo below (The delivered ferrite could differ from the ferrite on the photography below).

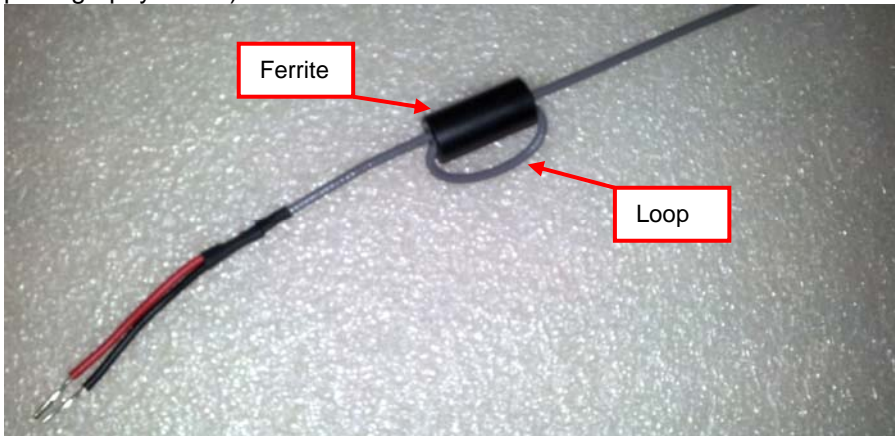

Picture 13 Ferrite mounted on cable with one loop

**Power Supply (AC or DC → pls. see type plate)**

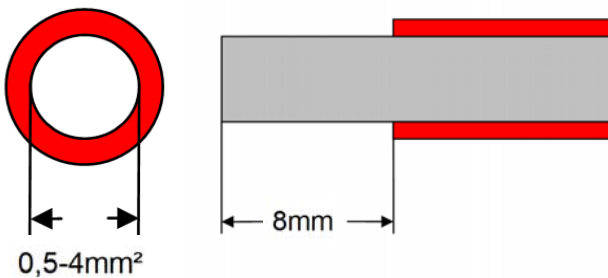

For power supply please use cables with a cross section of ca. 0.5...4 mm<sup>2</sup>. Solid cables should be dismantled about 8 mm to allow proper contact to terminals.

**I/O Terminal**

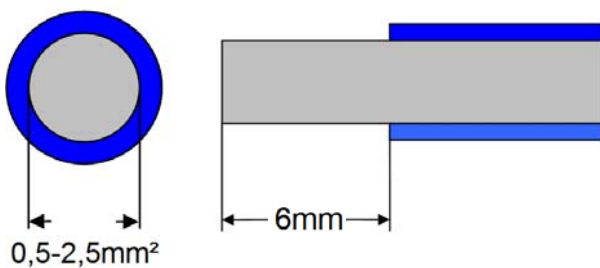

For I/O terminals please use cables with a cross section of ca. 0.5...2.5 mm<sup>2</sup>. Solid cables should be dismantled about 6mm to allow proper contact to terminals.

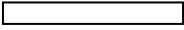
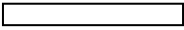
Terminalname	Colour	Description
UP1	ORANGE 	Connection for upstream transducer (red cable = + / black cable = -), Channel 1
DWN1		Connection for downstream transducer (red cable = + / black cable = -), Channel 1
UP2	RED 	Connection for upstream transducer (red cable = + / black cable = -), Channel 2
DWN2		Connection for downstream transducer (red cable = + / black cable = -), Channel 2

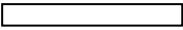
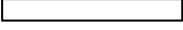
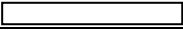
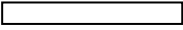
PT100 No. 1	YELLOW 	Input for temperature sensor. Left terminal is for the „colder“ temperature (return pipe)
PT100 No. 2		Input for temperature sensor. Right terminal is for the „hotter“ temperature (feed pipe)
Relay	GREEN 	Relay, potential-free
AO1 4-20 mA	BLUE 	Analog output 1 (4...20 mA), active, 24 VDC
AO1 4-20 mA		Analog output 2 (4...20 mA), active, 24 VDC
Digital out DO1	WHITE 	Universal digital output 1 (transistor), <b>for configuration of the digital outputs pls. read the user main manual.</b>
Digital out DO2		Universal Digital output 2 (transistor), <b>for configuration of the digital outputs pls. read the user main manual.</b>
Power Supply		Please provide either 90-240 VAC or 8-36 VDC (depending on chosen model). Please make sure that you use the correct voltage. <b>Flow transmitter might be damaged when using wrong supply.</b>

**Note: All in- and outputs (except relay) have defined potential on the internal devices ground. For potential free operation of the in- and outputs is additional hardware needed (with galvanic isolation). With the normal in- and output it is not possible.**

**Manufactured and sold by:**

Kobold Messring GmbH  
 Nordring 22-24  
 D-65719 Hofheim  
 Tel.: +49(0)6192-2990  
 Fax: +49(0)6192-23398  
 E-Mail: info.de@kobold.com  
 Internet: [www.kobold.com](http://www.kobold.com)

**Version K01/0915**

# DUC-ZUWD Quickstart



## Prepare your wall thickness gauge /Keypad definition

The delivery is usually ready to use; batteries (AA).



Switch on / off



Backlight on / off



Scroll down / decrease



Exit



Menu / Select



Scroll up / Increase



Enter



Calibration



Connect the signal cables of the transducer to the thickness gauge

Calibration sample

## 3 steps to parameterize your wall thickness gauge

1. Please check if the sensor probe type is set correctly (standard type 'N07')
2. Make calibration using integrated calibration sample
3. Set value for speed of sound of your pipe material.
4. Place probe on the pipe and get reading for wall thickness



**Please make sure to put some coupling grease on the sensor tip before measurement. Calibration should be repeated each time you start new measurement. Calibration should be done at speed of sound of 5920 m/s**



Pic. 1



Pic. 2





Pic. 3





Pic. 4

Put some coupling grease (Magnalube) on the probe tip (Pic.1). Put sensor on the integrated calibration sample (Pic.2) which you find in the lowermost right corner of the instrument.

Press button . Display will show 4.00 mm. Remove the probe. Your DUC-ZUWD is now calibrated. Now set the speed of sound of media

of pipe material. Press button  (4x) to go to menu for setting of speed of sound. (lowermost line, right corner), see pic.3.

The value can be changed by using buttons  . Values for typical materials can be obtained from the adjacent table. Put sensor tip on your pipe and take readings from display, see pic.4.

### Manufactured and sold by:

Kobold Messring GmbH  
 Nordring 22-24  
 D-65719 Hofheim  
 Tel.: +49 (0)6192-2990  
 Fax: +49(0)6192-23398  
 E-Mail: info.de@kobold.com  
 Internet: www.kobold.com

Material	Vm/s
Iron	5930
Steel	5920
Rubber	2311
Cast Iron	5100
Stainless Ste	5740
Copper	4720
Lead	2400
Aluminium	6360
Brass	4399
PVC	2388
Plexiglass	2692
Polystyrene	2337
Glass	5639
Concrete	4000
Epoxy	2540
PE	1900
Teflon	1422