

Economical Oval-Gear Flow Meter

For Viscous Oils



measuring
•
monitoring
•
analyzing

OVZ

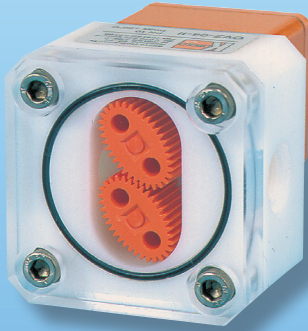

- Suitable for Clean, Lubricating Oils
- Maintains Precision with Viscosity Change
- Five Material Combinations Available
- Economically Priced
- Easy to Maintain
- Optional Analog Output, Frequency Output or Digital Indicating Output Options



KOBOLD companies worldwide:

ARGENTINA, AUSTRIA, BELGIUM, BULGARIA, CANADA, CHILE, CHINA, COLOMBIA, CZECH REPUBLIC, EGYPT, FRANCE, GERMANY, GREAT BRITAIN, HUNGARY, INDIA, INDONESIA, ITALY, MALAYSIA, MEXICO, NETHERLANDS, PERU, POLAND, ROMANIA, SINGAPORE, SOUTH KOREA, SPAIN, SWITZERLAND, TAIWAN, THAILAND, TUNISIA, TURKEY, USA, VIETNAM

Authorized Distributor:
ControlSystemsUsa.com
Houston, TX USA
832-615-3588
sales@ControlSystemsUsa.com



Description

KOBOLD OVZ flowmeters offer the advantages of positive displacement technology at a rotameter price. Suitable for viscous media ranging from hydraulic oils to light gear oils, the OVZ eliminates problems associated with viscosity changes during operation. The OVZ's cost conscious design allows for easy maintenance. Since the only wear components are the gears and their axles, a two step rebuild process can be performed in a few minutes with no recalibration required. The OVZ is available with either Hall-effect or inductive sensors, and a selection of output signals. NPN, PNP, or NAMUR configurations are ideal for connecting to a wide variety of controller devices, including KOBOLD's full line of frequency input devices. The OVZ is also available with analog, frequency, or digital indication output options. Typical applications for the OVZ include central lubrication systems for paper machines, filling transmission fluid into gearboxes, and low pressure hydraulic systems.

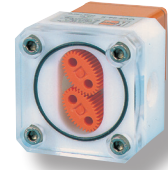

Specifications

Accuracy:	±2.5% of f. s.
Turn-Down:	10:1
Viscosity Range:	10...800 cSt
Required Filtration:	30 micron filter recommended
Temp. Range:	14...176 °F
Maximum Pressure Limits	
Differential:	15 PSI
Static	
Material I:	145 PSIG
Material II:	145 PSIG
Material III:	230 PSIG
Material IV:	230 PSIG
Material V:	580 PSIG
Wetted Parts	
Oval Gears:	POM
Axle:	Stainless steel
Housing:	POM or aluminum
Housing Cover:	POM, PMMA, aluminum, or polysulfone
O-Ring:	NBR, FKM, or EPDM

Electronics

Frequency Output (..I401; ..I302; ..I303)	
Power Supply:	5-24 V _{DC}
Power Consumption:	Typically 10 mA
Pulse Output:	Hall effect sensor NPN, asymmetrical, open collector, max. 15 mA
Electr. Connection:	Connector socket DIN 43650 (..I401) aluminium adapter box with cable connection (..I302) aluminium cover box with circular connector M12x1 (..I303)

Frequency Output (..I304)

Power Supply:	18-30 V _{DC}
Power Consumption:	Typically 10 mA
Pulse Output:	PNP, asymmetrical, open collector max. 120 mA
Electr. Connection:	2 m PVC cable

Frequency Output (..I305)

Power Supply:	Nominal 8.2 V _{DC}
Pulse Output:	NAMUR, asymmetrical, max. approx. 3.5 mA (typ. 0.5 mA)
Electr. Connection:	2 m PVC cable

Frequency Output (..F300)

Power Supply:	12-28 V _{DC}
Power Consumption:	10 mA
Pulse Output:	PNP, open collector, max. 25 mA
Electr. Connection:	Connector M12x1

Frequency Output with Frequency Divider (..F390)

Power Supply:	24 V _{DC} ±20%
Power Consumption:	15 mA
Pulse Output:	PNP, open collector, max. 25 mA
Electr. Connection:	Connector M12x1
Divisional Factor:	Acc. to customer specification

Analog Output (..L343, ..L443)

Power Supply:	24 V _{DC} ±20%
Output:	4-20 mA, 3-wire
Max. Load:	500 Ω
Electr. Connection:	Connector M12x1 or DIN 43650
Option:	Plug-on display AUF-3000 (with DIN connector only)

Compact Electronics

Display:	3-digit LED
Analog Output:	4...20 mA adjustable, max. 500 Ω
Switching Outputs:	1 (2) semiconductor PNP or NPN, factory setting
Contact Operation:	N/C, N/O programmable
Setting:	Via 2 keys
Power Supply:	24 V _{DC} ±20%, 3-wire, appr. 100 mA
Electr. Connection:	Connector M12x1

Pointer Indication with Analog Output

Housing:	Aluminum
Indication:	Moving coil instrum., 240° indication
Power Supply:	24 V _{DC} ±20%
Output:	4-20 mA, 3-wire
Max. Load:	250 Ω
Electr. Connection:	Connector M12x1

Totalizing and Batching Electronics available upon request



Order Details for POM Plastic Housing (Example: **OVZ-02 1 N2 N I304**)

Rated Measuring Range ¹⁾ (GPM)				Pulses/ Gallon ²⁾	Model Number	Cover Material	Connection (NPT)	Connection (G)	O-ring Material
10 cSt	100 cSt	320 cSt	800 cSt						
0.08...2.1	0.08...2.1	0.05...1.3	0.03...0.53	1623	OVZ-02..	..1 = POM ..2 = PMMA	..N2 = 1/4" NPT	..G2 = G 1/4	..N.. = NBR
0.11...2.6	0.11...2.6	0.08...2.1	0.04...1.1	847	OVZ-04..		..N2 = 1/4" NPT	..G2 = G 1/4	..V.. = FKM
0.26...6.6	0.26...6.6	0.26...6.6	0.11...2.6	199	OVZ-15..		..N4 = 1/2" NPT	..G4 = G 1/2	..E.. = EPDM
0.42...10.6	0.42...10.6	0.42...10.6	0.25...6.34	106	OVZ-30..		..N5 = 3/4" NPT	..G5 = G 3/4	

¹⁾ Maximum pressure loss at maximum rated flow is 14.5 PSIG

²⁾ Hz = Pulses/Gallon x Gallon/min/60

Order Details for Aluminum Housing (Example: **OVZ-02 5 N2 V I303**)

Rated Measuring Range ¹⁾ (GPM)				Pulses/ Gallon ²⁾	Model Number	Cover Material	Connection (NPT)	Connection (G)	O-ring Material
10 cSt	100 cSt	320 cSt	800 cSt						
0.08...2.1	0.08...2.1	0.07...1.74	0.03...0.79	1379	OVZ-02..	..3 = PMMA	..N2 = 1/4" NPT	..G2 = G 1/4	..N.. = NBR
0.11...2.6	0.11...2.6	0.11...2.64	0.07...1.19	768	OVZ-04..	..4 = PSU	..N2 = 1/4" NPT	..G2 = G 1/4	..V.. = FKM
0.26...6.6	0.26...6.6	0.24...6.08	0.13...3.30	176	OVZ-15..	..5 = ALU	..N4 = 1/2" NPT	..G4 = G 1/2	..E.. = EPDM
0.42...10.6	0.42...10.6	0.34...8.85	0.21...5.28	98	OVZ-30..		..N5 = 3/4" NPT	..G5 = G 3/4	

¹⁾ Maximum pressure loss at maximum rated flow is 14.5 PSIG

²⁾ Hz = Pulses/Gallon x Gallon/min/60

Order Details for Outputs and Electronics

Frequency Output			
	..I401	Frequency output NPN	DIN connector 43650
	..I302	Frequency output NPN	Cable Connection
	..I303**	Frequency output NPN	Connector M12x1
	..I304***	Frequency output PNP	2 m PVC cable
	..F300	Frequency output PNP	Connector M12x1
	..F390	Frequency divider adjusted PNP	Connector M12x1
Analog Output			
	..L343	4-20 mA output, 3-wire	M12x1 plug connector
	..L443	4-20 mA output, 3-wire	DIN4 connector 43650
Compact Electronics*			
	..C30R	LED display, 2x open collector, PNP	Plug connector M12x1
	..C30M	LED display, 2x open collector, NPN	Plug connector M12x1
	..C34P	LED display, 4-20 mA, 1x open collector PNP	Plug connector M12x1
	..C34N	LED display, 4-20 mA, 1x open collector, NPN	Plug connector M12x1
Pointer Indication*			
	..Z340	240° pointer indicator, 4-20 mA	Plug connector M12x1

Order Details for Accessory: AUF-3000

Order Number	Description
AUF-3000	Plug-in display for OVZ...L443
	3 position LED
	DIN 43 650 plug connector
	3-wire, power through analog output

*When ordering, please specify the direction of flow

**Available only in aluminum housing models

***Available only in POM housing models



Economical Oval-Gear Flow Meter Model OVZ

Pressure Losses (POM Plastic Housing)

OVZ-02..

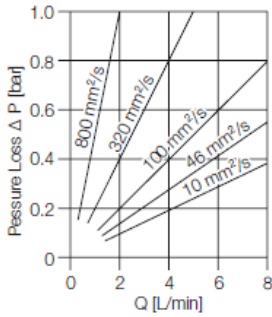

OVZ-04..

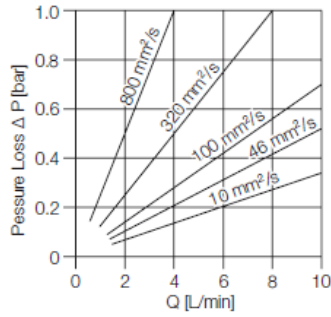

OVZ-15..

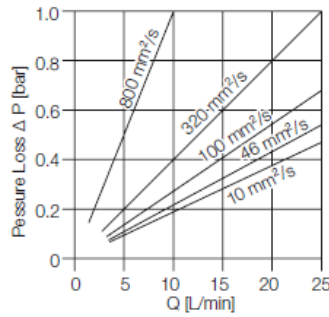

OVZ-30..

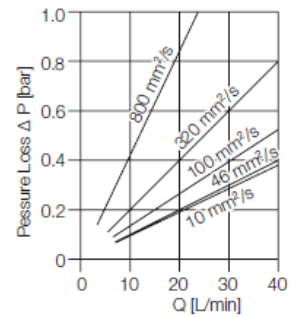

Pressure Losses (Aluminum Housing)

OVZ-02..

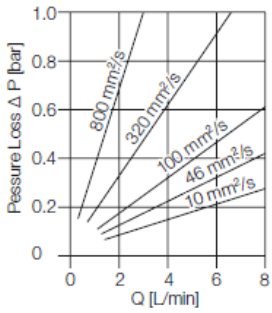

OVZ-04..

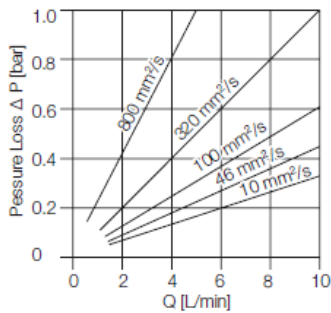

OVZ-15..

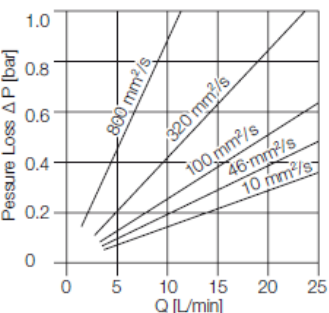

OVZ-30..

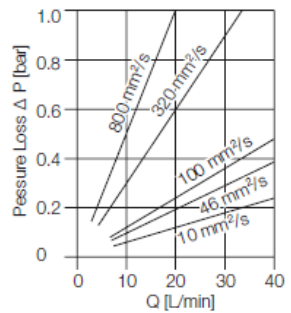

Electrical Connection

OVZ-..I401

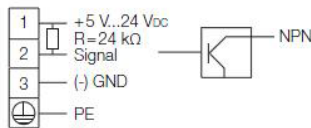

OVZ-..I302

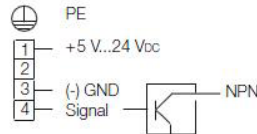

OVZ-..I303

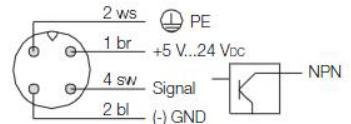

OVZ-..I304

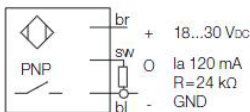

OVZ-..I305

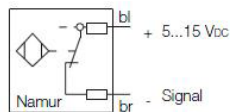

OVZ-..L443

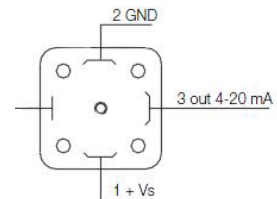

OVZ-..F., OVZ-..Z., OVZ-..L3..

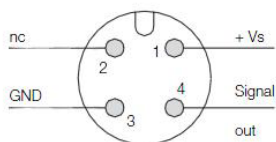

OVZ-..C..

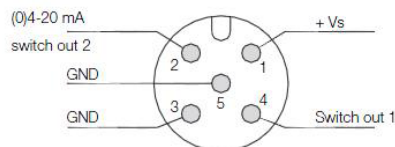

Dimensions

OVZ-...I401

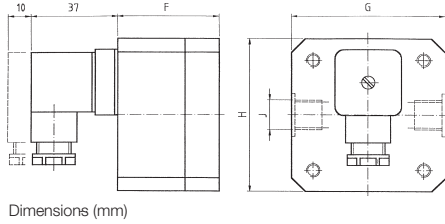

Range	G	H	F (per Body Materials)			
			1	2	3/4	5
OVZ-02	2.67"	2.67"	1.77"	1.77"	1.71"	1.61"
OVZ-04	2.67"	2.67"	1.93"	1.93"	1.85"	1.75"
OVZ-15	3.90"	3.90"	2.80"	2.87"	2.80"	2.60"
OVZ-30	4.59"	4.59"	3.33"	3.44"	3.39"	3.13"

OVZ-...I302, OVZ-...I303

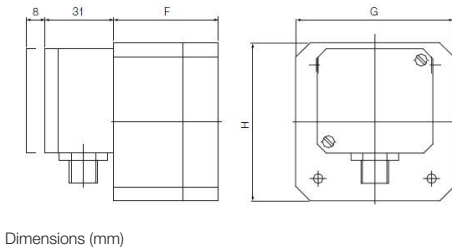

Range	G	H	F (per Body Materials)			
			1	2	3/4	5
OVZ-02	2.67"	2.67"	1.77"	1.77"	1.71"	1.61"
OVZ-04	2.67"	2.67"	1.93"	1.93"	1.85"	1.75"
OVZ-15	3.90"	3.90"	2.80"	2.87"	2.80"	2.60"
OVZ-30	4.59"	4.59"	3.33"	3.44"	3.39"	3.13"

OVZ-...I304, OVZ-...I305

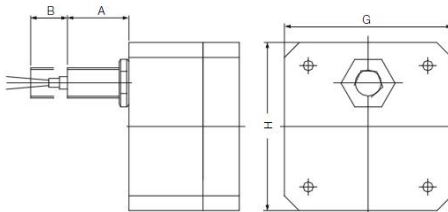

Range	PNP		NAMUR		PNP/NAMUR	
	A	B	C	D	G	H
OVZ-02	0.85"	0.53"	0.65"	0.53"	2.67"	2.67"
OVZ-04	0.83"	0.55"	0.63"	0.55"	2.67"	2.67"
OVZ-15	0.75"	0.63"	0.55"	0.63"	3.90"	3.90"
OVZ-30	0.67"	0.71"	0.47"	0.71"	4.59"	4.59"

OVZ with Frequency or Analog Output

OVZ-...L3..

OVZ-...F3..

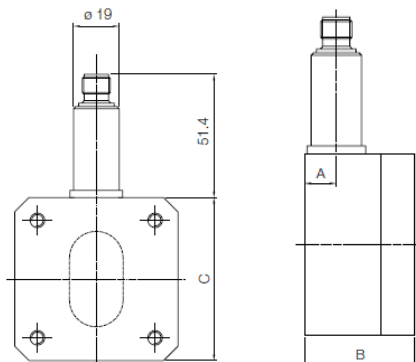

Plastic Housing (POM)

Description	A	B	C
OVZ-02 1 = POM	0.51"	1.77"	2.68"
OVZ-02 2 = PMMA	0.51"	1.77"	2.68"
OVZ-04 1 = POM	0.54"	1.93"	2.68"
OVZ-04 2 = PMMA	0.54"	1.93"	2.68"
OVZ-15 1 = POM	0.62"	2.80"	3.90"
OVZ-15 2 = PMMA	0.62"	2.87"	3.90"
OVZ-30 1 = POM	0.69"	3.33"	4.69"
OVZ-30 2 = PMMA	0.69"	3.44"	4.69"



Dimensions

OVZ with Frequency or Analog Output

OVZ-..L443 with AUF-3000

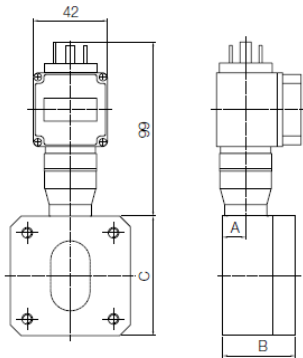

Aluminum Housing (ALU)

Description	A	B	C
OVZ-02 3 = PMMA	0.45"	1.72"	2.68"
OVZ-02 4 = PSU	0.45"	1.72"	2.68"
OVZ-02 5 = ALU	0.45"	1.62"	2.68"
OVZ-04 3 = PMMA	0.45"	1.85"	2.68"
OVZ-04 4 = PSU	0.45"	1.85"	2.68"
OVZ-04 5 = ALU	0.45"	1.75"	2.68"
OVZ-15 3 = PMMA	0.53"	2.80"	3.90"
OVZ-15 4 = PSU	0.53"	2.80"	3.90"
OVZ-15 5 = ALU	0.53"	2.60"	3.90"
OVZ-30 3 = PMMA	0.62"	3.39"	4.69"
OVZ-30 4 = PSU	0.62"	3.39"	4.69"
OVZ-30 5 = ALU	0.62"	3.13"	4.69"

OVZ with Compact Electronic and Pointer Indication

OVZ-..C3..

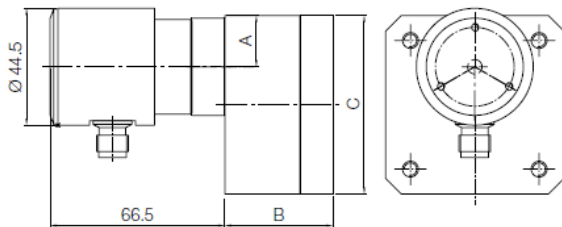

Plastic Housing (POM)

Description	A	B	C
OVZ-02 1 = POM	0.77"	1.77"	2.68"
OVZ-02 2 = PMMA	0.77"	1.77"	2.68"
OVZ-04 1 = POM	0.67"	1.93"	2.68"
OVZ-04 2 = PMMA	0.67"	1.93"	2.68"
OVZ-15 1 = POM	0.83"	2.80"	3.90"
OVZ-15 2 = PMMA	0.83"	2.87"	3.90"
OVZ-30 1 = POM	0.91"	3.33"	4.69"
OVZ-30 2 = PMMA	0.91"	3.44"	4.69"

OVZ-..Z3..

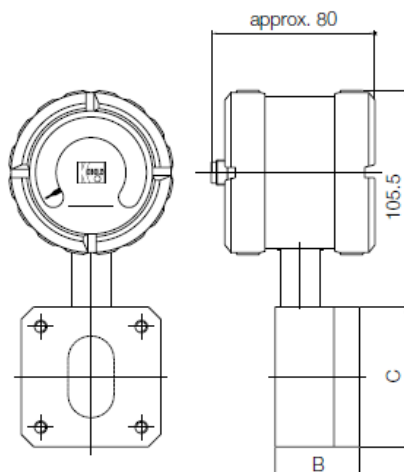

Aluminum Housing (ALU)

Description	A	B	C
OVZ-02 3 = PMMA	0.77"	1.72"	2.68"
OVZ-02 4 = PSU	0.77"	1.72"	2.68"
OVZ-02 5 = ALU	0.77"	1.62"	2.68"
OVZ-04 3 = PMMA	0.77"	1.85"	2.68"
OVZ-04 4 = PSU	0.77"	1.85"	2.68"
OVZ-04 5 = ALU	0.77"	1.75"	2.68"
OVZ-15 3 = PMMA	0.83"	2.80"	3.90"
OVZ-15 4 = PSU	0.83"	2.80"	3.90"
OVZ-15 5 = ALU	0.83"	2.60"	3.90"
OVZ-30 3 = PMMA	0.91"	3.39"	4.69"
OVZ-30 4 = PSU	0.91"	3.39"	4.69"
OVZ-30 5 = ALU	0.91"	3.13"	4.69"