

Signet 2551 Blind Magmeter



3-2551.090 Rev. P 04/16

Operating Instructions



Description

The Signet 2551 Magmeter is an insertion-style magnetic flow sensor. The patented sensor design is available in a variety of corrosion-resistant materials to provide long-term reliability and minimal maintenance costs. Wetted material combinations include PP/316 SS, PVDF/Hastelloy-C and PVDF/Titanium. The 2551 installs quickly and securely into a wide selection of flow fittings to deliver accurate flow measurement in pipe sizes ranging from DN15 to DN900 (½ in. to 36 in.).

Signet 2551 Magmeters are available with a frequency output or Digital (S³L) output for use with the Signet 9900-1BC Batch Controller, 8900 Multi-Parameter Controller or 9900 Transmitter, or with a 4 to 20 mA output for a direct input to a PLC, SCADA or telemetry system.

All 2551 Magmeters feature empty pipe detection and LED-assisted diagnostics. The Signet 3-0252 Configuration Tool set-up tool is available to customize every performance feature in the 2551 to adapt it to the specific application requirements.

Table of Contents

- Quick Start 2
- Warranty Information 2
- Product Registration 2
- Safety Information 2
- Chemical Compatibility 2
- Specifications 3
- Dimensions 3
- Installation: Pipe Fittings 4
- Selecting a Location 4
- Hardware Configuration 5
- General Installation and Grounding Tips 6
- Wiring with 4 to 20 mA Loop 6
- Wiring with Frequency or Digital (S³L) Output 7
- Calibration and Software Configuration 7
- Calibration Data 8
- Maintenance and Troubleshooting 10
- Ordering Information 11



- [English](#)
- [Deutsch](#)
- [Français](#)
- [Español](#)
- [Italiano](#)
- [Português](#)



AUTHORIZED DISTRIBUTOR:
ControlSystemsUSA.com
Houston, Texas USA
sales@ControlSystemsUSA.com
832-615-3588

Warranty Information

Refer to your local Georg Fischer Sales office for the most current warranty statement.

All warranty and non-warranty repairs being returned must include a fully completed Service Form and goods must be returned to your local GF Sales office or distributor. Product returned without a Service Form may not be warranty replaced or repaired.

Signet products with limited shelf-life (e.g. pH, ORP, chlorine electrodes, calibration solutions; e.g. pH buffers, turbidity standards or other solutions) are warranted out of box but not warranted against any damage, due to process or application failures (e.g. high temperature, chemical poisoning, dry-out) or mishandling (e.g. broken glass, damaged membrane, freezing and/or extreme temperatures).

Product Registration

Thank you for purchasing the Signet line of Georg Fischer measurement products.

If you would like to register your product(s), you can now register online in one of the following ways:

- Visit our website www.gfsignet.com. Under **Service and Support** click on **Product Registration Form**
- If this is a pdf manual (digital copy), [click here](#)

Chemical Compatibility

The retaining nuts of Magmeters are not designed for prolonged contact with aggressive substances. Strong acids, caustic substances and solvents or their vapor may lead to failure of the retaining nut, ejection of the sensor and loss of the process fluid with possibly serious consequences, such as damage to equipment and serious personal injury. Retaining nuts that may have been in contact with such substances, e.g. due to leakage or spilling, must be replaced.

Dimensions

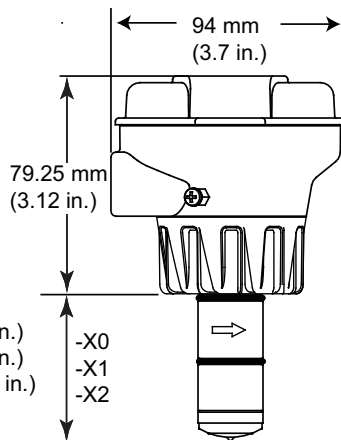

Pipe Range:

- 1/2 to 4 in. -X0 = 58 mm (2.3 in.)
- 5 to 8 in. -X1 = 91 mm (3.6 in.)
- 10 to 36 in. -X2 = 167 mm (6.6 in.)

X = Sensor Body P, T, or V

Safety Information

Depressurize and vent system prior to installation or removal. Confirm chemical compatibility before use. Do not exceed maximum temperature/pressure specifications. Wear safety goggles or face shield during installation/service. Do not alter product construction. Disconnect power before attempting any service or wiring.

	Caution / Warning / Danger Indicates a potential hazard. Failure to follow all warnings may lead to equipment damage, injury, or death
	Electrostatic Discharge (ESD) / Electrocutation Danger Alerts user to risk of potential damage to product by ESD, and/or risk of potential of injury or death via electrocution.
	Personal Protective Equipment (PPE) Always utilize the most appropriate PPE during installation and service of Signet products.
	Pressurized System Warning Sensor may be under pressure, take caution to vent system prior to installation or removal. Failure to do so may result in equipment damage and/or serious injury.
	Hand Tighten Only Overtightening may permanently damage product threads and lead to failure of the retaining nut.
	Do Not Use Tools Use of tool(s) may damage product beyond repair and potentially void product warranty.

Operating Temperature/Pressure

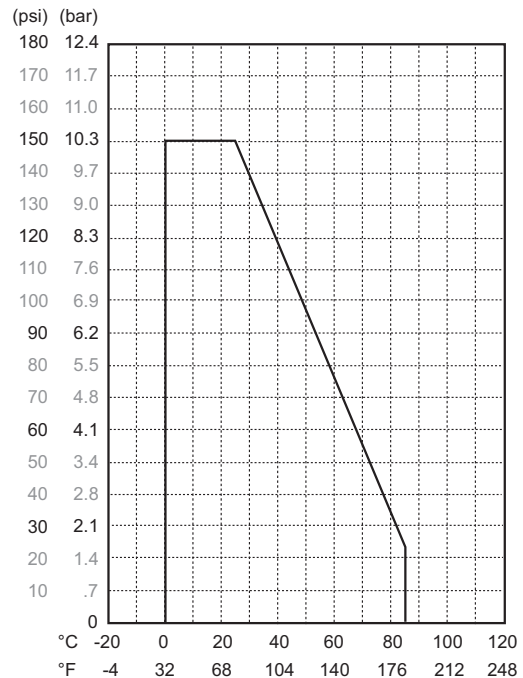

Specifications

General

Pipe size range.....DN15 to DN 900 (0.5 in. to 36 in.)
 Flow Range
 Minimum0.05 m/s (0.15 ft/s)
 Maximum10 m/s (33 ft/s)
 Linearity± 1% reading plus 0.01m/s (0.033 ft/s)
 Repeatability.....± 0.5% of reading @ 25 °C (77 °F)
 Min. Conductivity20 µS/cm

Wetted Materials

Sensor body and Electrodes and Grounding ring
 -P0, -P1, -P2Polypropylene and 316L SS
 -T0, -T1, -T2.....PVDF and Titanium
 -V0, -V1,-V2PVDF and Hastelloy-C
 O-ringsFPM (standard);
 EPDM, FFKM (optional)



The user is responsible for determining the chemical suitability of these materials for a specific application.

Electrical

Power Requirements
 4 to 20 mA21.6 to 26.4 VDC, 22.1 mA max.
 Frequency.....5 to 26.4 VDC, 15 mA max.
 Digital (S³L).....5 to 6.5 VDC, 15 mA max.
 Reverse polarity and short circuit protected

Current output (4 to 20 mA)

Loop Accuracy32 µA max. error (25 °C @ 24 VDC)
 IsolationLow voltage < 48 VAC/DC from
 electrodes and auxiliary power
 Max cable300 m (1000 ft)
 Error condition22.1 mA
 Max. Loop Resistance300 Ω
 Compatible with PLC, PC or similar equipment

Frequency output

Max. Pull-up Voltage.....30 VDC
 Compatible with Signet 8900, 9900, 9900-1BC

Digital (S³L) Output

Serial ASCII, TTL level 9600 bps
 Compatible with Signet 8900, 9900
 Max. cable lengthApplication dependent (See 8900 manual)

Environmental Requirements

Enclosure.....NEMA 4X / IP65 (with cap installed)
 CasePBT
 Display.....Polyamide
 Storage Temperature.....-20 °C to 70 °C (-4 °F to 158 °F)
 Relative Humidity.....0 to 95% (non-condensing)
 Operating Temperature
 Ambient.....-10 °C to 70 °C (14 °F to 158 °F)
 Media0 °C to 85 °C (32 °F to 185 °F)
 Maximum
 Operating pressure10.3 bar @ 25 °C (150 psi @ 77 °F)
 1.4 bar @ 85 °C (20 psi @ 185 °F)

Standards and Approvals

- CE, UL/CUL
- NSF (3-2551-P versions only)
- RoHS compliant
- China RoHS (visit gfsignet.com for details)
- Manufactured under ISO 9001 for Quality,
 ISO 14001 for Environmental Management and
 OHSAS 18001 for Occupational Health and Safety.

FC Declaration of Conformity according to FCC Part 15

This device complies with Part 15 of the FCC rules.
 Operation is subject to the following two conditions:
 (1) This device may not cause harmful interference, and,
 (2) This device must accept any interference received,
 including interference that may cause undesired operation.

Quick Start

This manual contains the general installation, wiring and calibration data for the Signet 2551-XX-11 Magmeter with Frequency or Digital (S³L) data output, and for the Signet 2551-XX-12 Magmeter with 4 to 20 mA output. The basic steps are outlined on this page. See each referenced section for detailed information.

1. Configure the Hardware

2551-XX-11 ONLY: Position this Jumper to select Digital (S³L) output or Frequency output. Pg. 5.

2. Position the PIPE SIZE jumper according to your pipe size. Pg. 5.

3. Install the Magmeter into the pipe. Use Signet installation fittings ONLY. The installation fitting is critical to Magmeter performance. Pg. 4.

4. Connect POWER and OUTPUT wiring.

Frequency out: Pg. 7.
 Digital (S³L) out: Pg. 7.
 4 to 20 mA out: Pg. 6.

GROUNDING Without a good earth ground, the Magmeter may not operate efficiently. Pg. 6.



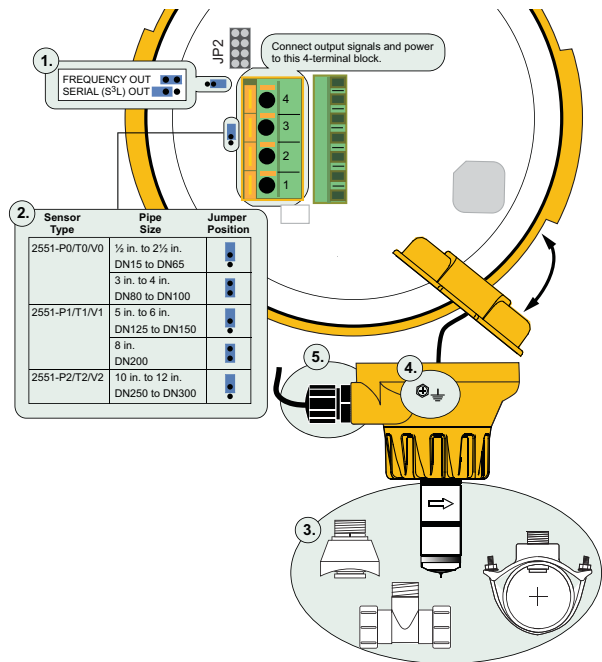





5. Route the wiring out through the two cable ports. Use appropriate hardware to secure the 2551 from moisture intrusion. One Liquid Tight Connector is included. Pg. 5.



Installation

Pipe fittings

Georg Fischer offers a wide selection of installation fittings that control the position of the Magmeter electrodes in relation to the dimensions of the pipe. You will find a complete list of order numbers for installation fittings in the Calibration Tables on pages 8, 9.

Type	Description
 <p>Plastic tees</p>	<ul style="list-style-type: none"> • 0.5 in. to 2 in. versions • MPVC or CPVC
 <p>PVC Glue-on Saddles</p>	<ul style="list-style-type: none"> • 10 in. and 12 in. only • Cut 2½ in. hole in pipe • Weld in place using solvent cement
 <p>PVC Clamp-on Saddles</p>	<ul style="list-style-type: none"> • 2 in. to 4 in., cut 1-7/16 inch hole in pipe • 6 in. to 8 in., cut 2-1/8 in. hole in pipe
 <p>Iron Strap-on saddles</p>	<ul style="list-style-type: none"> • 2 in. to 4 in., cut 1-7/16 inch hole in pipe • Over 4 inch, cut 2-1/8 inch hole in pipe • Special order 14 in. to 36 in.
 <p>Iron, Carbon Steel & 316 Stainless Steel Threaded Tees</p>	<ul style="list-style-type: none"> • 0.5 in. to 2 in. versions • Mounts on Threaded pipe ends
 <p>Carbon steel & Stainless Steel Weld-on Weldolets</p>	<ul style="list-style-type: none"> • 2 in. to 4 in., cut 1-7/16 inch hole in pipe • Over 4 inch, cut 2-1/8 inch hole in pipe
 <p>Fiberglass Tees</p> <p>FPT</p>	<ul style="list-style-type: none"> • 1.5 in. to 2 in. PVDF insert
 <p>Union Fittings and Wafers</p>	<ul style="list-style-type: none"> • For pipes from DN 15 mm to 50 mm PP or PVDF

Location of Fitting

To ensure the fluid velocity profile is Fully Developed, without distortion from piping system components, please adhere to the recommended straight run geometry.

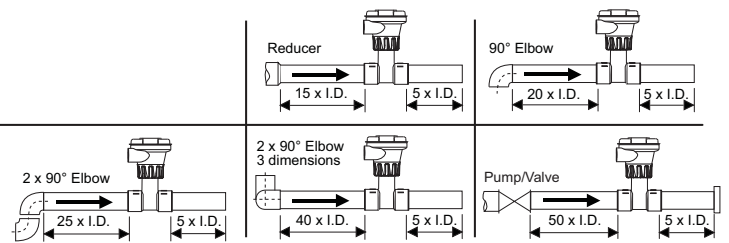

Sensor Mounting Position

Horizontal pipe Runs

To minimize adverse effects of air pockets, sediment, or excessive rotor wear (Paddlewheels), avoid mounting the flow sensor at the top of the pipe (0°), bottom of pipe (180°), or the sides (90° from vertical).

Vertical Pipe Runs

Mount flow sensors in any direction. To ensure pipe is flowing full, with some back pressure, it's highly recommended the fluid flow is upward.

Gravity and Discharge Lines

It's recommended to install a trap to ensure pipe is full during flow conditions, and to minimize air pockets.

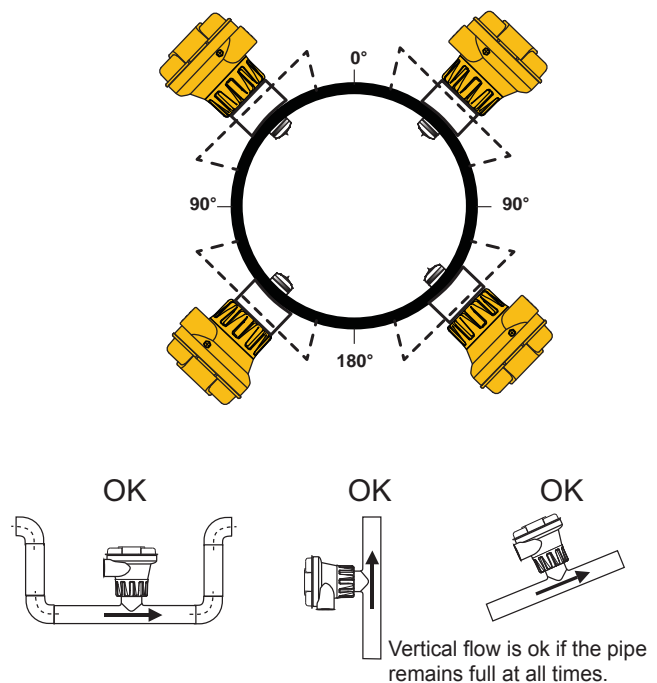

Hardware Configuration

Whether using the 2551-XX-11 (with frequency or Digital (S³L) output) or the 2551-XX-12 (with 4 to 20 mA output), the wiring terminals located on the inside of the yellow cover are identical. All of the connections from the Magmeter to external equipment (PLC, Datalogger, Chart Recorder, Flow meter, etc.) are made at the large 4-position terminal connector.

When the cover is removed the wiring from the sensor can be seen connected to the smaller terminal block. These connections should always remain connected to prevent inadvertent damage or miswiring.

The terminals on the 2551 Magmeter are designed for conductors from 16 AWG to 22 AWG.



WARNING!

If the second conduit port is used, carefully drill the opening. (The plastic is too strong to be punched out.)

- Secure the Magmeter in a vise to prevent damage or injury.
- The plastic inside the port is very thin. Do not allow the drill to penetrate too deeply and damage the Magmeter wiring.

Important:

- The directional arrow on the sensor body MUST be pointed DOWNSTREAM for correct operation. (Digital (S³L) and 4 to 20 mA will not work if flow is against direction of arrow).
- The FLOW arrow decal can be placed directly on the pipe to identify the direction of flow.
- Use a cable gland or a liquid tight connector to seal the cable ports from water intrusion.
- The yellow housing may be reversed to align the conduit ports as required.
- If the Magmeter is installed on a vertical pipe, the conduit ports should be turned to point downward.
- This will prevent condensation from being channeled into the enclosure.
- Use plumber's tape or a suitable sealant on cable ports.

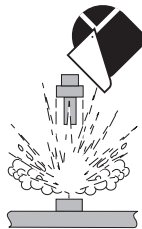
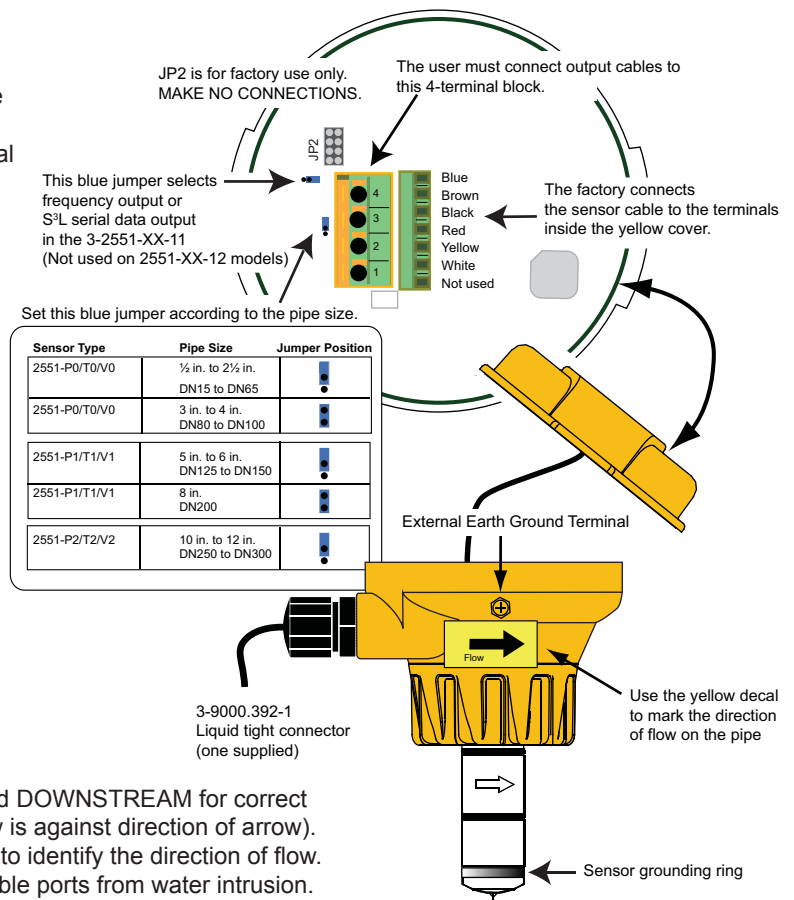

FAILURE TO FOLLOW THESE INSTRUCTIONS MAY RESULT IN THE SENSOR BEING EJECTED FROM THE PIPE!

- DO NOT USE ANY TOOLS ON THE RETAINING CAP. HAND TIGHTEN ONLY.
- LUBRICATE O-RINGS WITH A NON-PETROLEUM BASED, VISCOUS LUBRICANT (GREASE) COMPATIBLE WITH THE SYSTEM.
- DO NOT USE THREAD SEALANT OR LUBRICANTS ON THE RETAINING CAP OR ON THE PLASTIC FITTING THREADS.
- IF LEAKING IS OBSERVED FROM THE RETAINING CAP, IT INDICATES DEFECTIVE OR WORN O-RINGS ON THE SENSOR. DO NOT ATTEMPT TO CORRECT BY FURTHER TIGHTENING.

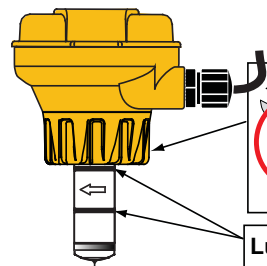

Do not use any tools to tighten the yellow retaining cap. DO NOT USE thread sealant or lubricants on retaining cap!

Lubricate O-rings with a viscous non-petroleum based lubricant (grease) compatible with the system.

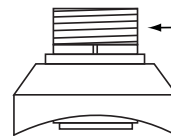

DO NOT USE thread sealant or lubricants on the fitting threads.

CHEMICAL COMPATIBILITY WARNING

The retaining nuts of Magmeters are not designed for prolonged contact with aggressive substances. Strong acids, caustic substances and solvents or their vapor may lead to failure of the retaining nut, ejection of the sensor and loss of the process fluid with possibly serious consequences, such as damage to equipment and serious personal injury. Retaining nuts that may have been in contact with such substances, e.g. due to leakage or spilling, must be replaced.

General Installation and Grounding Tips

Sensor conditioning

The Magmeter output signal may be unstable immediately after installation. Allowing the sensor to soak in a full pipe (or in any container of water) for 24 hours will stabilize the performance.

- Very low conductivity fluids may require a longer conditioning period. (The Magmeter will not operate properly in fluids where the conductivity is less than 20 $\mu\text{S}/\text{cm}$.)

Grounding

The 2551 Magmeter is unaffected by moderate levels of electrical noise. However, in some applications it may be necessary to ground portions of the system to eliminate electrical interference. The grounding requirements will vary with each installation.

1. One or more of the following steps may be applied if the 2551 Magmeter is affected by electrical noise:
 - The ground terminal on the outside of the yellow housing is connected internally to the grounding ring at the tip of the sensor.
 - Connect a wire (14 AWG/2.08 mm^2 recommended) from this terminal directly to a local Earth ground.
2. Install fluid grounding devices immediately upstream and downstream of the Magmeter.
 - Connect the fluid grounds to the Earth ground terminal on the 2551.
 - Use flanged grounding rings or metal electrodes on plastic pipes, or metal clamps on metal pipes.
 - Fluid grounds must be in direct contact with the fluid, and as near to the Magmeter as possible.
3. The shield from the output cable must be terminated at the remote instrument ONLY. This shield must be connected at only one end!
4. Connect an additional wire (minimum AWG 14/2.08 mm^2) from the remote instrument ground to the Magmeter ground terminal.

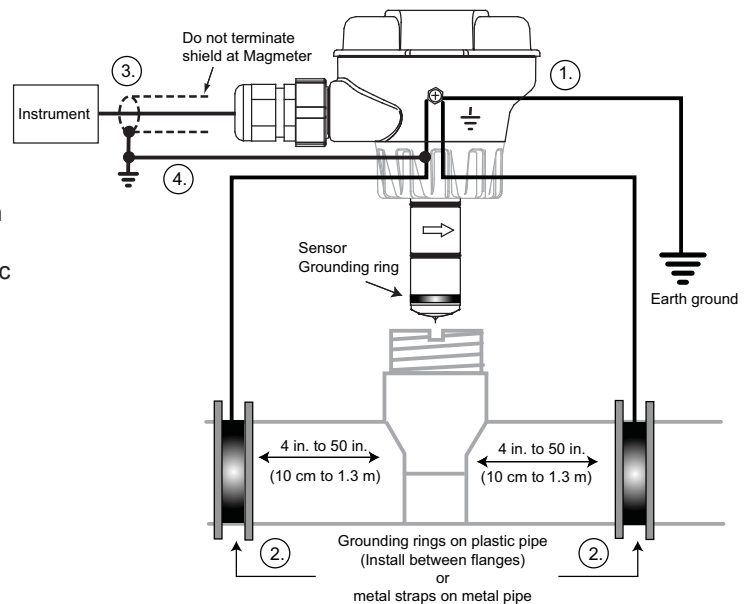

Wiring with 4 to 20 mA Loop Output

The 2551-XX-12 Magmeter is a traditional 2-wire passive 4 to 20 mA loop transmitter.

- External loop power (24 VDC \pm 10%) is required. See Ordering Information for power supplies.
- **The maximum loop resistance the Magmeter can accommodate is 300 Ω .**
- All 2551-XX-12 Magmeters are shipped from the factory with the 4 to 20 mA output scaled for 0 to 5 m/s (0 to 16.4 ft/s). If this operating range is suitable, no adjustments are necessary.
- The Calibration Tables on pages 8-9 list the 20 mA setpoint for each installation fitting. Use this information to program the 4 to 20 mA range of the loop device (PLC, Datalogger, recorder, etc.)
- The 3-0250 USB to Digital (S³L) Configuration/Diagnostic Tool is required to change the operating range.

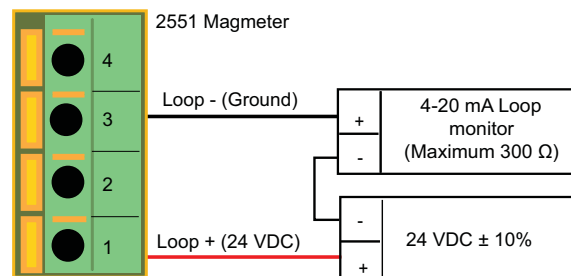

Wiring with Frequency or Digital (S³L) Output

Frequency output (Compatible with all POWERED Signet Flow instruments.)

- When the blue jumper illustrated here is placed over both pins, the 2551-XX-11 outputs an open collector frequency signal that can be connected to any powered Signet flow meter (models 8900, 9900, 9900-1BC).
- 5 VDC power is provided to the 2551 Magmeter by all Signet flow instruments. No additional power is required.
- The frequency output will be displayed as positive flow regardless of the flow direction.**

Blue Jumper ON = FREQ OUT

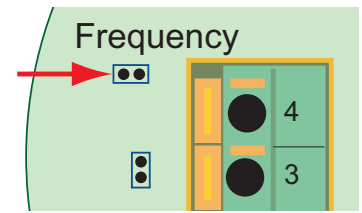

2551 Wiring to Signet 8900

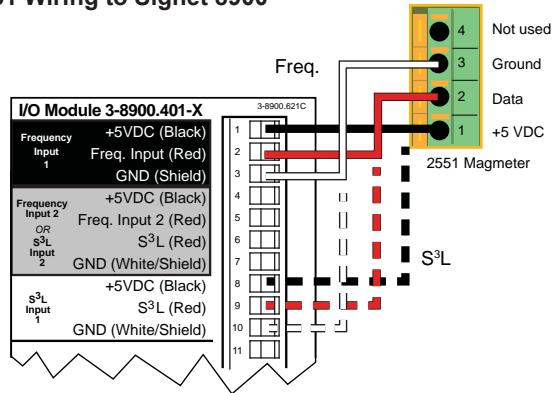

2551 Wiring to Signet 9900 and 9900-1BC

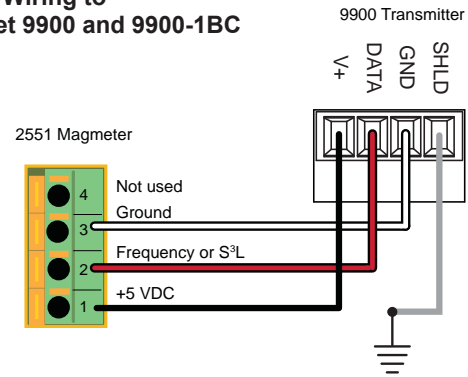

Digital (S³L) Output (Compatible with 8900 Multi-Parameter Controller and 9900 Transmitter Only)

- When the blue jumper illustrated here is removed (or placed over one pin for storage) the 2551-XX-11 outputs a Digital (S³L) signal compatible with the Signet 8900 and 9900.
- The 2551 receives 5 VDC power from the 8900 or 9900. No additional power is required.
- The 8900 will display 0 (Zero) flow rate during periods of reverse flow. The 9900 will display negative numbers to indicate reverse flow.**
- The maximum cable length from the 2551 to the 8900 or 9900 depends on the 8900 or 9900 configuration. Refer to the 8900 or 9900 manual for complete information.

Blue Jumper OFF = S³L OUT

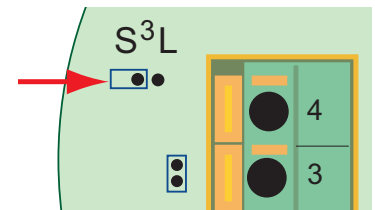

2551 Frequency Out to other manufacturer's equipment

- If connecting the 2551 Magmeter to a flow instrument from another manufacturer, 5 to 24 VDC power must be provided to the 2551.
- A 10 KΩ pull-up resistor (not supplied) must also be connected between terminals 1 and 2.

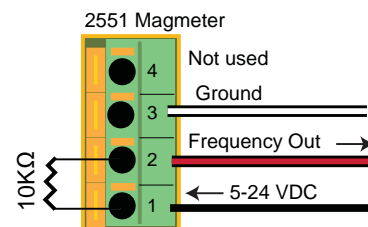

Install a pull-up resistor when connecting the 2551 Magmeter to other manufacturer's flowmeters.

Calibration and Software Configuration

No calibration is necessary to begin using the 2551. The application and performance settings are pre-set to meet the requirements of most applications.

The 2551 application and performance settings can be customized using the Signet 3-0252 Configuration Tool and software. Refer to the Signet 3-0252 Configuration Tool manual for details to adjust the following parameters:

- 4 to 20 mA span:** Factory setting is 0 to 5 m/s. Can be customized to any range.
- Noise Rejection Filter:** Factory set for 60 Hz. Can be changed to 50 Hz.
- Low Flow Cutoff:** Factory setting is 0.05 m/s. Can be customized to any velocity.
- Averaging Time:** Factory setting is 14 seconds. Can be customized from 0.1 seconds to 100 seconds.
- Sensitivity:** Factory setting is 25% of full scale. Can be customized to any % of full scale.

Calibration Data: K-Factors and Full Scale Current Values

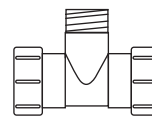
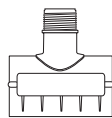

Plastic Installation Fittings: PVC Tees and Saddles

Pipe Size (In.)	Fitting Type	K-Factor Gallons	K-Factor Liters	20 mA= in GPM	20 mA= in LPM
SCH 80 PVC-U TEES FOR SCH 80 PVC PIPE					
½	MPV8T005	2277.0	601.58	13.1	49.6
¾	MPV8T007	1407.6	371.90	20.97	79.38
1	MPV8T010	861.17	227.52	34.21	129.5
1¼	MPV8T012	464.91	122.83	67.1	253.99
1½	MPV8T015	331.43	87.56	92.54	350.25
2	MPV8T020	192.89	50.96	145.15	549.38

Pipe Size (In.)	Fitting Type	K-Factor Gallons	K-Factor Liters	20 mA= in GPM	20 mA= in LPM
SCH 80 PVC TEES FOR SCH 80 PVC PIPE					
2½	PV8T025	131.46	34.73	228.2	863.74
3	PV8T030	82.52	21.80	363.55	1376.04
4	PV8T040	44.78	11.83	669.88	2535.49

Pipe Size (In.)	Fitting Type	K-Factor Gallons	K-Factor Liters	20 mA= in GPM	20 mA= in LPM
SCH 80 PVC TEES FOR SCH 80 CPVC PIPE					
½	MCPV8T005	2277.0	601.58	13.18	49.87
¾	MCPV8T007	1407.6	371.90	21.31	80.67
1	MCPV8T010	861.17	227.52	34.84	131.86
1¼	MCPV8T012	464.91	122.83	64.53	244.24
1½	MCPV8T015	331.43	87.56	90.52	342.62
2	MCPV8T020	192.89	50.96	155.53	588.70

Pipe Size (In.)	Fitting Type	K-Factor Gallons	K-Factor Liters	20 mA= in GPM	20 mA= in LPM
SCH 80 PVC SADDLES FOR SCH 80 PVC PIPE					
2	PV8S020	193.83	51.21	154.77	585.81
2½	PV8S025	138.01	36.46	217.38	822.78
3	PV8S030	83.89	22.16	357.62	1353.60
4	PV8S040	40.88	10.80	733.88	2777.74
6	PV8S060	22.53	5.95	1331.85	5041.06
8	PV8S080	12.52	3.31	2395.41	9066.64
10	PV8S100	7.94	2.10	3778.75	14302.57
12	PV8S120	5.71	1.51	5256.69	19896.57

Pipe Size (In.)	Fitting Type	K-Factor Gallons	K-Factor Liters	20 mA= in GPM	20 mA= in LPM
SCH 80 PVC SADDLES FOR SCH 40 PVC PIPE					
2	PV8S020	180.01	47.56	166.66	630.81
2½	PV8S025	123.72	32.69	242.49	917.82
3	PV8S030	75.81	20.03	395.71	1497.76
4	PV8S040	41.87	11.06	716.56	2712.19
6	PV8S060	19.71	5.21	1521.92	5760.46
8	PV8S080	11.73	3.10	2558.12	9682.50
10	PV8S100	7.43	1.96	4037.60	15282.3
12	PV8S120	5.23	1.38	5734.87	21706.48

Plastic Installation Fittings for Metric Pipes: Polypropylene True Union Tees and Wafers PVDF True Union Tees, PVC True Union Tees

Pipe Size (Metric)	Fitting Type	K-Factor Gallons	K-Factor Liters	20 mA= in GPM	20 mA= in LPM
POLYPROPYLENE FITTINGS (DIN/ISO, BS, ANSI)					
DN15	PPMT005	2192.73	579.32	13.68	51.78
DN20	PPMT007	1327.81	350.81	22.59	85.52
DN25	PPMT010	737.16	194.76	40.70	154.04
DN32	PPMT012	453.46	119.81	66.16	250.41
DN40	PPMT015	275.03	72.66	109.08	412.86
DN50	PPMT020	164.17	43.35	182.74	691.66

Pipe Size (Metric)	Fitting Type	K-Factor Gallons	K-Factor Liters	20 mA= in GPM	20 mA= in LPM
PVDF FITTINGS (DIN/ISO, BS, ANSI)					
DN15	SFMT005	1946.49	514.26	15.41	58.34
DN20	SFMT007	1158.05	305.96	25.91	98.05
DN25	SFMT010	749.09	197.91	40.05	151.58
DN32	SFMT012	439.51	116.12	68.26	258.36
DN40	SFMT015	248.93	65.77	120.52	456.16
DN50	SFMT020	146.85	38.80	204.30	773.26

Pipe Size (Metric)	Fitting Type	K-Factor Gallons	K-Factor Liters	20 mA= in GPM	20 mA= in LPM
PVC FITTINGS (DIN/ISO, BS, ANSI)					
DN15	PVMT005	2067.76	546.30	14.51	54.91
DN20	PVMT007	1136.61	300.29	26.39	99.90
DN25	PVMT010	716.52	189.31	41.87	158.47
DN32	PVMT012	446.07	117.85	67.25	254.56
DN40	PVMT015	278.83	73.67	107.59	407.23
DN50	PVMT020	159.36	42.10	188.26	712.55

Metal Installation Fittings Iron Saddles

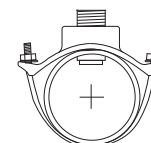

Pipe Size (In.)	Fitting Type	K-Factor Gallons	K-Factor Liters	20 mA= in GPM	20 mA= in LPM
SCH 80 IRON SADDLE ON SCH 80 PIPE					
2	IR8S020	194.85	51.48	153.96	582.75
2½	IR8S025	142.28	37.59	210.86	798.10
3	IR8S030	87.53	23.13	342.72	1297.20
4	IR8S040	40.62	10.73	738.58	2795.54
5	IR8S050	29.28	7.74	1024.43	3877.48
6	IR8S060	22.30	5.89	1345.58	5093.03
8	IR8S080	12.52	3.31	2395.41	9066.64
10	IR8S100	7.94	2.10	3778.75	14302.57
12	IR8S120	5.65	1.49	5311.45	20103.83

Pipe Size (In.)	Fitting Type	K-Factor Gallons	K-Factor Liters	20 mA= in GPM	20 mA= in LPM
SCH 80 IRON SADDLE ON SCH 40 PIPE					
2	IR8S020	185.35	48.97	161.85	612.61
2½	IR8S025	127.47	33.68	235.36	890.83
3	IR8S030	76.62	20.24	391.54	1481.99
4	IR8S040	40.23	10.63	745.72	2822.57
5	IR8S050	27.32	7.22	1098.24	4156.83
6	IR8S060	19.71	5.21	1521.92	5760.46
8	IR8S080	11.61	3.07	2584.23	9781.30
10	IR8S100	7.36	1.94	4078.8	15438.2
12	IR8S120	5.18	1.37	5793.39	21927.98

Calibration Data: K-Factors and Full Scale Current Values

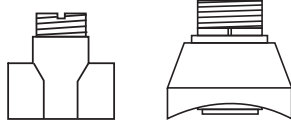

Metal Installation Fittings:

Carbon Steel Tees and Weld-o-Lets

Stainless Steel Tees and Weld-o-Lets, Galvanized Iron Tees

Pipe Size (In.)	Fitting Type	K-Factor Gallons	K-Factor Liters	20 mA= in GPM	20 mA= in LPM
CARBON STEEL TEES ON SCH 40 PIPE					
½	CS4T005	1572.66	415.50	19.08	72.20
¾	CS4T007	1086.73	287.11	27.61	104.49
1	CS4T010	582.34	153.86	51.52	194.99
1¼	CS4T012	377.48	99.73	79.48	300.81
1½	CS4T015	267.79	70.75	112.03	424.02
2	CS4T020	167.85	44.35	178.73	676.48

STAINLESS STEEL TEES ON SCH 40 PIPE

½	CR4T005	1601.26	423.05	18.74	70.91
¾	CR4T007	937.78	247.76	31.99	121.08
1	CR4T010	606.18	160.15	49.49	187.32
1¼	CR4T012	279.68	73.89	107.26	405.99
1½	CR4T015	147.65	39.01	203.19	769.06
2	CR4T020	111.90	29.56	268.09	1014.73

STAINLESS STEEL WELDOLETS ON SCH 40 PIPE

2½	CR4W025	106.31	28.09	282.19	1068.10
3	CR4W030	72.27	19.09	415.12	1571.25
4	CR4W040	36.84	9.73	814.34	3082.28
5	CR4W050	29.28	7.73	1024.70	3878.50
6	CR4W060	20.29	5.36	1478.26	5595.21
8	CR4W080	11.73	3.10	2557.72	9680.96
10	CR4W100	7.45	1.97	4028.83	15249.13
12	CR4W120	5.24	1.39	5722.73	21660.53

CARBON STEEL WELDOLETS ON SCH 40 PIPE

2½	CS4W025	105.70	27.93	283.82	1074.27
3	CS4W030	70.68	18.67	424.45	1606.56
4	CS4W040	36.38	9.61	824.65	3121.30
5	CS4W050	29.28	7.73	1024.70	3878.50
6	CS4W060	20.29	5.36	1478.26	5595.21
8	CS4W080	11.73	3.10	2557.72	9680.96
10	CS4W100	7.45	1.97	4028.83	15249.13
12	CS4W120	5.24	1.39	5722.73	21660.53

GALVANIZED IRON TEES ON SCH 40 PIPE

1	IR4T010	558.50	147.56	53.71	203.31
1¼	IR4T012	334.45	88.36	89.70	339.51
1½	IR4T015	248.97	65.78	120.49	456.07
2	IR4T020	146.00	38.57	205.48	777.76

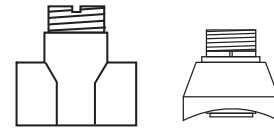

Metal Installation Fittings:

Bronze and Copper Tees and Brazolets

Pipe Size (In.)	Fitting Type	K-Factor Gallons	K-Factor Liters	20 mA= in GPM	20 mA= in LPM
BRONZE TEES ON SCH 40 PIPE					
1	BR4T010	582.34	153.86	51.52	194.99
1¼	BR4T012	330.54	87.33	90.76	343.53
1½	BR4T015	254.76	67.31	117.76	445.71
2	BR4T020	157.36	41.58	190.64	721.58

COPPER TEES FITTING ON COPPER PIPE SCH K

½	CUKT005	2459.19	649.72	12.20	46.17
¾	CUKT007	1108.02	292.74	27.08	102.48
1	CUKT010	649.87	171.70	46.16	174.73
1¼	CUKT012	422.03	111.50	71.09	269.06
1½	CUKT015	281.43	74.35	106.60	403.47
2	CUKT020	136.02	35.94	220.55	834.78

COPPER TEES FITTING ON COPPER PIPE SCH L

½	CUKT005	2406.30	635.75	12.47	47.19
¾	CUKT007	1174.77	310.37	25.54	96.66
1	CUKT010	672.28	177.62	44.62	168.90
1¼	CUKT012	402.84	106.43	74.47	281.87
1½	CUKT015	294.99	77.94	101.70	384.92
2	CUKT020	149.63	39.53	200.50	758.89

COPPER/BRONZE BRAZOLET ON SCH 40 PIPE

2½	BR4B025	117.31	30.99	255.74	967.96
3	BR4B030	78.62	20.77	381.58	1444.28
4	BR4B040	45.13	11.92	664.77	2516.15
5	BR4B050	32.79	8.66	914.91	3462.95
6	BR4B060	22.73	6.01	1319.87	4995.72
8	BR4B080	13.14	3.47	2283.68	8643.71
10	BR4B100	8.34	2.20	3597.17	13615.29
12	BR4B120	5.87	1.55	5109.58	19339.76

Maintenance

The 2551 Magmeter requires very little maintenance. There are no user-serviceable components in the Magmeter.

- If the fluid contains deposits and solids that may coat the electrodes, a regular cleaning schedule is recommended.
- Do not use abrasive materials on the metal electrodes. Clean with soft cloth and mild detergent only.
- Use a cotton swab and mild detergent to remove deposits on the metal electrodes at the tip of the sensor.

Environmental Recommendations:

- When used properly, this product presents no inherent danger to the environment.
- Please follow local ordinances when disposing of this or any product with electronic components.

Troubleshooting

Symptom	Possible Cause	Solution
Output is erratic and unstable.	Magmeter installed too close to upstream obstruction.	Relocate the magmeter to have straight uninterrupted pipe upstream of the sensor for at least 10 x the pipe diameter.
	Magmeter located in area exposed to air bubbles/pockets.	Eliminate air bubbles in the pipe.
	Magmeter is installed in pipe backwards.	Remove the magmeter and reinstall with the flow direction arrow on the sensor body pointed DOWNSTREAM.
	Electrical noise is interfering with the measurement.	Review the grounding of the magmeter and the pipe. Install adequate Earth ground to allow the Magmeter to operate properly.
	Electrodes are coated with solids.	Carefully clean the electrodes. Refer to sensor manual for details.
	New sensor; metal surface not properly conditioned.	Soak sensor overnight in fluid.
Output is not 0 when flow is stopped.	Electrodes not adequately conditioned.	Soak sensor overnight in fluid.
	Vibration or other movement in pipe causes magmeter to detect flow.	Increase the Low Flow Cutoff.
	Electrical noise interference.	Modify grounding to protect the Magmeter from interference.
	Defective Magmeter.	Return to factory for service.
4-20 mA current output is incorrect.	Loop device not scaled same as Magmeter.	Use 3-0250 Setup tool to re-span the Magmeter to match Loop device. Re-span Loop device to match Magmeter.
	Range Jumper not placed correctly.	Set Range Jumper correctly.
	Defective Magmeter.	Return to factory for service
Frequency output is inoperative Digital (S ³ L) output is inoperative. Loop output is inoperative.	2551 is wrong model.	Frequency/S ³ L model: 3-2551-XX-11
	Blue jumper not in correct position.	Place blue jumper correctly. (Pg. 4)
	Wiring is not correct.	Check wiring, make corrections. (Pg. 7)
Output is 22.1 mA	Frequency input to other manufacturer's flow instrument does not have pull-up resistor.	Install 10 kΩ resistor. (Pg. 7)
	Conductivity is less than 20 μS/cm (the fluid is too clean for Magmeter).	Unsuitable application for Magmeter.
	Electronic component failure.	Return 2551 to factory.

Troubleshooting

Troubleshooting with the RED and BLUE LEDs

Both Off:	The power is off or the sensor is not connected.
Solid Blue:	The power is on, the pipe is full, but there is no flow in the pipe.
Blinking Blue:	Normal operation, blink rate is proportional to the flow rate.
Alternating Red-Blue:	Empty pipe indication (electrodes are not wet).
Blinking Red:	System errors (electrical noise interference).
Solid Red:	Instrument error (defective electronics component).

If the 2551 detects an empty pipe:

- Frequency output will be locked to 0 Hz if electrodes are not wet.
- Digital (S³L) output will be locked to 0 if electrodes are not wet.
- 4 to 20 mA will be locked to 4 mA if electrodes are not wet.
- Blue and red LEDs will blink alternately if electrodes are not wet.

If the 2551 detects REVERSE FLOW:

- Frequency out cannot distinguish reverse flow from forward flow. The output will be the absolute value.
- With Digital (S³L) output, reverse flow results in 0 flow rate displayed on 8900 or with negative numbers on the 9900.
- 4-20 mA output can be spanned into negative flow range using the USB Setup Tool and software. (Page 7) (example: 4-20 mA = -100 to +100 GPM).

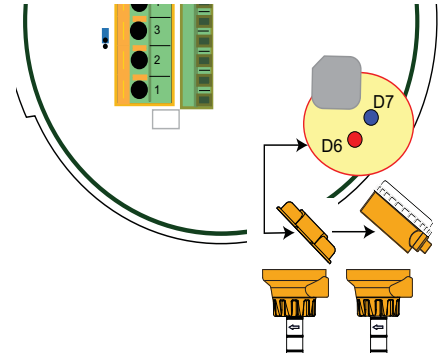

Ordering Information

Accessories and Replacement Parts

Mfr. Part No.	Code	Description
O-Rings		
1220-0021	198 801 000	O-ring, FPM (2 required per sensor)
1224-0021	198 820 006	O-ring, EPR (EPDM) (2 required per sensor)
1228-0021	198 820 007	O-ring, FFPM (2 required per sensor)
Replacement Transducers		
3-2551-P0	159 001 211	PP/316L SS, DN15 to DN100 (½ to 4 in.) pipe
3-2551-P1	159 001 212	PP/316L SS, DN125 to DN200 (5 to 8 in.) pipe
3-2551-P2	159 001 444	PP/316L SS, DN250 to DN900 (10 to 36 in.) pipe
3-2551-T0	159 001 213	PVDF/Titanium, DN15 to DN100 (½ to 4 in.) pipe
3-2551-T1	159 001 214	PVDF/Titanium, DN125 to DN200 (5 to 8 in.) pipe
3-2551-T2	159 001 445	PVDF/Titanium, DN250 to DN900 (10 to 36 in.) pipe
3-2551-V0	159 001 376	PVDF/Hastelloy-C, DN15 to DN100 (½ to 4 in.) pipe
3-2551-V1	159 001 377	PVDF/Hastelloy-C, DN125 to DN200 (5 to 8 in.) pipe
3-2551-V2	159 001 446	PVDF/Hastelloy-C, DN250 to DN900 (10 to 36 in.) pipe
Replacement Electronics Module		
3-2551-11	159 001 215	Magmeter electronics, frequency or digital (S ³ L) output
3-2551-12	159 001 216	Magmeter electronics, 4 to 20 mA output
3-2551-21	159 001 372	Magmeter display electronics, frequency or digital (S ³ L) output, with relays
3-2551-22	159 001 373	Magmeter display electronics, 4 to 20 mA output w/relays
3-2551-41	159 001 374	Magmeter display electronics, frequency or digital (S ³ L) output
3-2551-42	159 001 375	Magmeter display electronics, 4 to 20 mA output
Other		
P31536	198 840 201	Sensor plug, Polypropylene
7310-1024	159 873 004	24 VDC Power Supply, 0.42 A, 10W
7310-2024	159 873 005	24 VDC Power Supply, 1.0 A, 24W
7310-4024	159 873 006	24 VDC Power Supply, 1.7 A, 40W
7310-6024	159 873 007	24 VDC Power Supply, 2.5 A, 60W
7310-7024	159 873 008	24 VDC Power Supply, 4.0 A, 96W
3-8050.390-1	159 001 702	Retaining Nut Replacement Kit, NPT, Valox
3-8050.390-3	159 310 116	Retaining Nut Replacement Kit, NPT, PP
3-8050.390-4	159 310 117	Retaining Nut Replacement Kit, NPT, PVDF
3-9000.392-1	159 000 839	Liquid-tight connector kit, 1 set, ½ in. NPT
3-0252	159 001 808	0252 Configuration tool

Ordering Information

4 to 20 mA output

Mfr. Part No.	Code	Description
3-2551-P0-12	159 001 110	DN15 to DN100 (½ to 4 in.), Polypropylene and 316L SS
3-2551-T0-12	159 001 113	DN15 to DN100 (½ to 4 in.), PVDF and Titanium
3-2551-V0-12	159 001 259	DN15 to DN100 (½ to 4 in.), PVDF and Hastelloy-C
3-2551-P1-12	159 001 111	DN125 to DN200 (5 to 8 in.), Polypropylene and 316L SS
3-2551-T1-12	159 001 114	DN125 to DN200 (5 to 8 in.), PVDF and Titanium
3-2551-V1-12	159 001 260	DN125 to DN200 (5 to 8 in.), PVDF and Hastelloy-C
3-2551-P2-12	159 001 112	DN250 to DN900 (10 to 36 in.), Polypropylene and 316L SS
3-2551-T2-12	159 001 449	DN250 to DN900 (10 to 36 in.), PVDF and Titanium
3-2551-V2-12	159 001 451	DN250 to DN900 (10 to 36 in.), PVDF and Hastelloy-C

Frequency or Digital (S³L) output programmable open collector

Mfr. Part No.	Code	Description
3-2551-P0-11	159 001 105	DN15 to DN100 (½ to 4 in.), Polypropylene and 316L SS
3-2551-T0-11	159 001 108	DN15 to DN100 (½ to 4 in.), PVDF and Titanium
3-2551-V0-11	159 001 257	DN15 to DN100 (½ to 4 in.), PVDF and Hastelloy-C
3-2551-P1-11	159 001 106	DN125 to DN200 (5 to 8 in.), Polypropylene and 316L SS
3-2551-T1-11	159 001 109	DN125 to DN200 (5 to 8 in.), PVDF and Titanium
3-2551-V1-11	159 001 258	DN125 to DN200 (5 to 8 in.), PVDF and Hastelloy-C
3-2551-P2-11	159 001 107	DN250 to DN900 (10 to 36 in.), Polypropylene and 316L SS
3-2551-T2-11	159 001 448	DN250 to DN900 (10 to 36 in.), PVDF and Titanium
3-2551-V2-11	159 001 450	DN250 to DN900 (10 to 36 in.), PVDF and Hastelloy-C



Georg Fischer Signet LLC, 3401 Aero Jet Avenue, El Monte, CA 91731-2882 U.S.A. • Tel. (626) 571-2770 • Fax (626) 573-2057
For Worldwide Sales and Service, visit our website: www.gfsignet.com • Or call (in the U.S.): (800) 854-4090
For the most up-to-date information, please refer to our website at www.gfsignet.com